

# CT30 XP MOBILE COMPUTER

Configuration Guide



**SCAN HANDLE**



**WEARABLE**



**RFID**



**CT30 XP**



**CT30 XP  
HEALTHCARE**

THE  
FUTURE  
IS  
WHAT  
WE  
MAKE IT

**Honeywell**

# TABLE OF CONTENTS

- 1 TABLE OF CONTENTS**
- 2 CT30 XP FEATURE OVERVIEW**
  - S0703 STANDARD RANGE
  - N6803 FLEXRANGE™ NEAR/ FAR RANGE
  - S0703 STANDARD RANGE
  - NO SCANNER
  - HEALTHCARE - N6700 GREEN LINEAR LED AIMER - STANDARD RANGE
- 5 CT30 XP CONFIGURATION MAP**
  - ANDROID
- 6 HONEYWELL EDGE SERVICES**
  - GOLD REPAIR SERVICES - 3 YEAR
  - PLATINUM REPAIR SERVICES - 3 YEAR
  - GOLD REPAIR SERVICES - 5 YEAR
  - PLATINUM REPAIR SERVICES - 5 YEAR
  - CT30 XP - REPAIR SERVICES COVERAGE
- 9 CT30 XP SOFTWARE**
  - DEVICE CLIENT PACK
- 10 CT30 XP SCANNING**
  - SCAN HANDLE SIDE BY SIDE COMPARISON
  - OPTION 1 - SCAN HANDLE
  - OPTION 2 - SCAN HANDLE WITH PROTECTIVE BOOT
- 13 CT30 XP PROTECTIVE BOOT**
  - DOCKABLE PROTECTIVE BOOT
- 14 CT30 XP CARRY CLIP**
  - OPTION 1 – STANDARD CARRY CLIP
  - OPTION 2 – HEALTHCARE CARRY CLIP
- 15 CT30 XP DESKTOP COMMUNICATIONS**
  - OPTION 1 – USB TYPE C ON-THE-GO (OTG) DESKTOP
  - OPTION 2 – FIXED WITH UNIVERSAL CUP
  - OPTION 3 - DISPLAY BASE WITH UNIVERSAL CUP
- 17 CT30 XP CHARGING AND COMMUNICATION**
  - OPTION 1 - NON-BOOTED QUAD CHARGER WITH UNIVERSAL CUP
  - OPTION 2 - BOOTED QUAD CHARGER WITH UNIVERSAL CUP
  - OPTION 3 - NON-BOOTED 5-BAY CHARGE
  - OPTION 4 - BOOTED 5-BAY CHARGER
  - OPTION 5 - NON-BOOTED 5-BAY CHARGER WITH BATTERY CUP
  - OPTION 6 - BOOTED 5-BAY CHARGER WITH BATTERY CUP
  - OPTION 7 - QUAD BATTERY CHARGER
  - UNIVERSAL BATTERY CUP
- 21 CT30 XP HEALTHCARE CHARGING AND COMMUNICATION**
  - OPTION 1 - NON-BOOTED 5-BAY CHARGER WITH BATTERY CUP
  - OPTION 2 - BOOTED 5-BAY CHARGER WITH BATTERY CUP
  - OPTION 3 - DISPLAY BASE WITH UNIVERSAL CUP
  - OPTION 4 - QUAD BATTERY CHARGER
- 24 CT30 XP CHARGING AND COMMUNICATION**
  - RACK / WALL MOUNT BRACKET
- 25 CT30 XP BATTERY**
  - SPARE BATTERY OPTIONS
- 26 CT30 XP RFID**
  - IH40 RFID READER WITH CT30 XP NON-BOOTED
  - OPTION 1 - IH40 NON-BOOTED QUAD CHARGER
  - OPTION 2 - IH40 BOOTED QUAD CHARGER
  - OPTION 3 - IH40 QUAD BATTERY CHARGER
- 29 CT30 XP HEADSET**
  - USB-C CT30 XP PUSH TO TALK (PTT) HEADSET
- 30 CT30 XP WEARABLE**
  - WEARABLE KIT
  - WEARABLE KIT - REPLACEMENT PARTS
- 31 MISCELLANEOUS**
  - OPTIONAL PARTS
  - MICRO-SD CARDS
  - AC CORDS

# CT30 XP FEATURE OVERVIEW

## S0703 Standard Range

## N6803 FlexRange™ Near/ Far Range

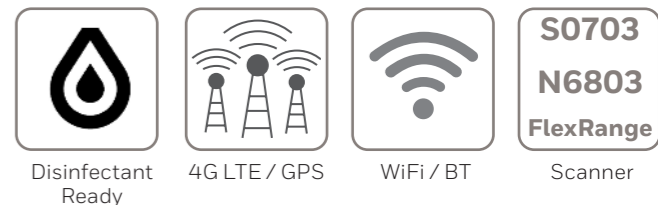

Included in the box:

- CT30 XP Mobile Computer
- Battery (CT30P-BTSC-001)
- USB Type C (CBL-500-120-S00-06)
- Handstrap



S0703 Standard Range



N6803 FlexRange™

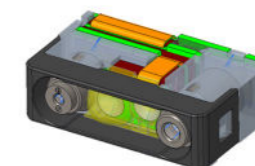

### CT30 XP Android - 4G WWAN 1 x eSIM & 1 x Nano SIM - WiFi 5 - S0703 - 6GB RAM/ 64GB Flash

#### CT30P-L1N-37D1EDG

CT30 XP Disinfectant Ready, WWAN, 6GB/64GB, 5.5 inch 2160x1080P full HD, S0703 Standard Range, 13MP Rear Camera/8MP Front Camera, 802.11a/b/g/n/ac/r/k/mc, 1 nano SIM & 1 eSIM, Bluetooth v5.1 & 2nd BLE, Android GMS, Battery, Warm Swap, IP67, USB 3.0 Type C OTG, Push To Talk (PTT)

### CT30 XP Android - 4G WWAN 1 x Nano SIM - WiFi 5 - S0703 - 6GB RAM/ 64GB Flash

#### CT30P-L1N-37D1NDG

CT30 XP Disinfectant Ready, WWAN, 6GB/64GB, 5.5 inch 2160x1080P full HD, S0703 Standard Range, 13MP Rear Camera/8MP Front Camera, 802.11a/b/g/n/ac/r/k/mc, 1 nano SIM, Bluetooth v5.1 & 2nd BLE, Android GMS, Battery, Warm Swap, IP67, USB 3.0 Type C OTG, Push To Talk (PTT)

### CT30 XP Android - WiFi 6 Only - S0703 - 6GB RAM/ 64GB Flash

#### CT30P-X0N-37D1ODG

CT30 XP Disinfectant Ready, WLAN, 6GB/64GB UFS, 5.5 inch 2160x1080P full HD, S0703 Standard Range, 13MP Rear Camera/8MP Front Camera, 802.11a/b/g/n/ac/r/k/mc/ax, 2x2 MIMO, Bluetooth v5.1 & 2nd BLE, Android GMS, Battery, Warm Swap, IP67, USB 3.0 Type C OTG, Push To Talk (PTT)

### CT30 XP Android - 4G WWAN 1 x eSIM & 1 x Nano SIM - WiFi 5 - N6803 - 6GB RAM/ 64GB Flash

#### CT30P-L1N-38D1EDG

CT30 XP Disinfectant Ready, WWAN, 6GB/64GB, 5.5 inch 2160x1080P full HD, N6803 FlexRange, 13MP Rear Camera/8MP Front Camera, 802.11a/b/g/n/ac/r/k/mc, 1 nano SIM & 1 eSIM, Bluetooth v5.1 & 2nd BLE, Android GMS, Battery, Warm Swap, IP67, USB 3.0 Type C OTG, Push To Talk (PTT)

### CT30 XP Android - 4G WWAN 1 x Nano SIM - WiFi 5 - N6803 - 6GB RAM/ 64GB Flash

#### CT30P-L1N-38D1NDG

CT30 XP Disinfectant Ready, WWAN, 6GB/64GB, 5.5 inch 2160x1080P full HD, N6803 FlexRange, 13MP Rear Camera/8MP Front Camera, 802.11a/b/g/n/ac/r/k/mc, 1 nano SIM, Bluetooth v5.1 & 2nd BLE, Android GMS, Battery, Warm Swap, IP67, USB 3.0 Type C OTG, Push To Talk (PTT)

### CT30 XP Android - WiFi 6 Only - N6803 - 6GB RAM/ 64GB Flash

#### CT30P-X0N-38D1ODG

CT30 XP Disinfectant Ready, WLAN, 6GB/64GB UFS, 5.5 inch 2160x1080P full HD, N6803 FlexRange, 13MP Rear Camera/8MP Front Camera, 802.11a/b/g/n/ac/r/k/mc/ax, 2x2 MIMO, Bluetooth v5.1 & 2nd BLE, Android GMS, Battery, Warm Swap, IP67, USB 3.0 Type C OTG, Push To Talk (PTT)

### Honeywell Repair Services

SVCCT30XP-SG3N

CT30 XP, Edge Service, Gold Maintenance Contract, 3 Year, New Contract

ADD SVCREPLACE-MOB3

AddOn, Edge Service, Device Replacement, Mobility, 3 Year

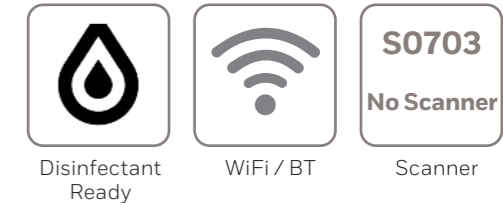

# CT30 XP FEATURE OVERVIEW

## S0703 Standard Range

### No Scanner

Included in the box:

- CT30 XP Mobile Computer
- Battery (CT30P-BTSC-001)
- USB Type C (CBL-500-120-S00-06)
- Handstrap



S0703 Standard Range



No Scanner



#### CT30 XP Android - WiFi 5 Only - S0703 - 4GB RAM/ 64GB Flash

**CT30P-LON-27D10NG**

CT30 XP Disinfectant Ready, WLAN, 4GB/64GB, 5.5 inch 2160x1080P full HD, S0703 Standard Range, 13MP Rear Camera/8MP Front Camera, 802.11a/b/g/n/ac/r/k/mc, BT5.1, Android GMS, Battery, Warm Swap, IP67, USB 3.0 Type C OTG, Push To Talk (PTT)

#### CT30 XP Android - WiFi 5 Only - No Scanner - 4GB RAM/ 64GB Flash

**CT30P-LON-2ND10NG**

CT30 XP Disinfectant Ready, WLAN, 4GB/64GB, 5.5 inch 2160x1080P full HD, No Scanner, 13MP Rear Camera/8MP Front Camera, 802.11a/b/g/n/ac/r/k/mc, BT5.1, Android GMS, Battery, Warm Swap, IP67, USB 3.0 Type C OTG, Push To Talk (PTT)

#### Honeywell Repair Services

SVCCT30XP-SG3N

CT30 XP, Edge Service, Gold Maintenance Contract, 3 Year, New Contract

ADD SVCREPLACE-MOB3

AddOn, Edge Service, Device Replacement, Mobility, 3 Year

# CT30 XP FEATURE OVERVIEW

## Healthcare - N6700 Green Linear LED Aimer - Standard Range

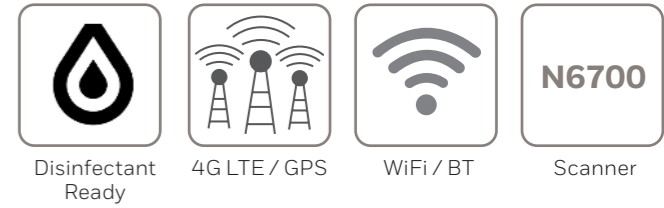

Included in the box:

- CT30 XP Healthcare Mobile Computer
- Healthcare Battery (CT30P-BTSC-002)

(CT30 XP Healthcare Carrying Clip is NOT included, but available to order separately as an accessory)



N6700 Standard Range



### CT30 XP Android - 4G WWAN 1 x eSIM & 1 x Nano SIM - WiFi 5 - N6700 - 6GB RAM/ 64GB Flash

#### CT30P-L1N-30D1EHG

CT30 XP Healthcare, WWAN, 6GB/64GB UFS, 5.5 inch 2160x1080P full HD, N6700 Standard Range, 13MP Rear Camera/8MP Front Camera, 802.11a/b/g/n/ac/r/k/mc, 1 nano SIM & 1 eSIM, Bluetooth v5.1 & 2nd BLE, Android GMS, Battery, Warm Swap, IP67, Push To Talk (PTT)

### CT30 XP Android - WiFi 6 Only - N6700 - 6GB RAM/ 64GB Flash

#### CT30P-X0N-30D10HG

CT30 XP Healthcare, WLAN, 6GB/64GB, 5.5 inch 2160x1080P full HD, N6700 Standard Range, 13MP Rear Camera/8MP Front Camera, 802.11a/b/g/n/ac/r/k/mc/ax, 2x2 MIMO, Bluetooth v5.1 & 2nd BLE, Android GMS, Battery, Warm Swap, IP67, Push To Talk (PTT)

### CT30 XP Android - 4G WWAN 1 x Nano SIM - WiFi 5 - N6700 - 6GB RAM/ 64GB Flash

#### CT30P-L1N-30D1NHG

CT30 XP Healthcare, WWAN, 6GB/64GB UFS, 5.5 inch 2160x1080P full HD, N6700 Standard Range, 13MP Rear Camera/8MP Front Camera, 802.11a/b/g/n/ac/r/k/mc, 1 nano SIM, Bluetooth v5.1 & 2nd BLE, Android GMS, Battery, Warm Swap, IP67, Push To Talk (PTT)

### Honeywell Repair Services

SVCCT30XP-SG3N







CT30 XP, Edge Service, Gold Maintenance Contract, 3 Year, New Contract

ADD SVCREPLACE-MOB3

AddOn, Edge Service, Device Replacement, Mobility, 3 Year

# CT30 XP CONFIGURATION MAP

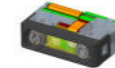
## Android

		BLUETOOTH/ WIFI	WWAN	NFC	MEMORY	IMAGER	CAMERA	OPERATING SYSTEM	SIM	OPTIONS	DOMAIN	DESCRIPTION	NOTES
<b>CT30P-</b>													
L												WiFi 5 802.11 a/b/g/n/ac + Bluetooth 5.1	IEEE 802.11 a/b/g/n/ac/d/e/h/i/k/r/w/mc ; Wi-Fi certified V5.1 Bluetooth and BLE Supported Bluetooth Profiles: HFP, PBAP, A2DP, AVRCP, OPP, SPP, GATT
X												WiFi 6 802.11 a/b/g/n/ac/ax + Bluetooth 5.1 2x2 MIMO	IEEE 802.11 a/b/g/n/ac/ax/d/e/h/i/k/r/w/mc ; Wi-Fi certified V5.1 Bluetooth and BLE Supported Bluetooth Profiles: HFP, PBAP, A2DP, AVRCP, OPP, SPP, GATT
	0											No WWAN	
	1											LTE (4G) GPS, UMTS/HSPA+ (3G) GSM/GPRS/EDGE	WWAN RADIO (ATT/VZW/SPRINT/TMO/NA/EU) LTE – BANDS 1,2,3,4,5,7,8,12,13,14,17,19,20,25,26,28,29,30,38,39,40,41,66,71 UMTS/HSPA+ (3G) – BANDS 1, 2, 4, 5, 6, 8, 9, 19 / GSM/GPRS/EDGE QUAD-BAND (850/900/1800/1900 MHZ)
				N								Near Field Communications (NFC)	Integrated NFC reader, compliant with ISO/IEC 14443 A, ISO/IEC 14443 B, ISO/IEC 15693 (ICODE), MIFARE 1K / 4K, MIFARE DESFire, Sony FeliCa, ISO/IEC 18092 (Type F)
				--									
					2							4GB RAM, 64GB Flash Memory	Qualcomm QCS4290/ QCM4290 octa-core 2.0GHz
					3							6GB RAM, 64GB Flash Memory	Qualcomm QCS4290/ QCM4290 octa-core 2.0GHz
						0						1D/2D Imager (N6700) – Standard Range	 
						7						1D/2D Imager (S0703SR) – Standard Range	 
						8						1D/2D Imager (N6803FR) – FlexRange™	 
						N						No Scanner	
							D					13MP Rear Camera / 8MP Front Camera	
								1				Android (GMS)	Google Mobile Services (GMS) certified – Play Store
								2				Android (Non-GMS)	
								0				No SIM slot	
								2				2 x Nano SIM Slots	
								E				1 x eSIM & 1 x Nano SIM Slot	
								N				1 x Nano SIM Slot	
								0				Standard	
								D				Disinfectant Ready Housing (DRH) with 2 <sup>nd</sup> Bluetooth Low Energy (BLE)	
								H				Healthcare Housing with 2nd Bluetooth Low Energy (BLE)	
								N				Disinfectant Ready Housing (DRH) without 2 <sup>nd</sup> Bluetooth Low Energy (BLE)	
								A				APAC / MERTA/ China ( WWAN Only)	APAC / MERTA/ China
								G				Global (WWAN or WiFi)	Algeria, Argentina, Australia, Austria, Belarus, Belgium, Bolivia, Brazil, Canada, Chile, Colombia , Costa Rica, Croatia, Czech Republic, Denmark, Dominican Republic, Ecuador, Egypt, Estonia, Finland, France, Germany, Greece, Guatemala, Hong Kong, Hungary, India, Ireland, Israel, Italy, Japan, Lithuania, Malaysia, Mexico, Morocco , Netherlands, New Zealand, Norway, Peru, Philippines, Poland, Portugal, Romania, Russian Fed., Saudi Arabia, Serbia, Singapore, Slovakia, Slovenia, South Africa, South Korea, Spain, Sweden, Switzerland, Taiwan, Thailand, Tunisia, Turkey, UAE, Ukraine, United Kingdom, United States of America
								J				Japan (WWAN Only)	Japan



# HONEYWELL EDGE SERVICES

## CT30 XP – Repair Services

Honeywell Edge Services give you the confidence of having leading-class technologies combined with service and support plans that are designed to keep you operational for longer.

### Gold Repair Services – 3 Year

The most flexible contract in the industry. The Edge Services Gold Support contract allows you to select the right coverage for your organization, including 5-Day Depot Repairs and:

#### Service Overview

- Repair or replacement of damaged components, wear and tear, and accidental damage.
- Flexibility to add any Add-On Service
- Android Service - includes Android OS Upgrades, Maintenance Releases and Security Patches

PART NUMBER	DESCRIPTION
SVCCT30XP-SG3N	CT30 XP, Edge Service, GOLD Maintenance Contract, 5 Day Turnaround, <b>3 Year</b> , New Contract

#### Add-On Accessory Replacement Service

Provides replacement chargers, docks, charging cables, or scan handles should they be damaged or stop working.

<b>ADD</b> SVCACC-MOB3	AddOn, Edge Service, Accessory Service , Mobility, <b>3 Year</b> . Service covers docks, charger cradles, scan handles
------------------------	------------------------------------------------------------------------------------------------------------------------

#### Add-On Battery Replacement Service

Provides replacement batteries every 18 months after purchase.

<b>ADD</b> SVCBATTERY-MOB3	AddOn, Edge Service, Battery Service, Mobility, <b>3 Year</b> , 1 Replacement Battery over life of contract
----------------------------	-------------------------------------------------------------------------------------------------------------

#### Add-On Device Replacement Service

Replacement devices should a device be damaged beyond repair.

<b>ADD</b> SVCREPLACE-MOB3	AddOn, Edge Service, Device Replacement, Mobility, <b>3 Year</b>
----------------------------	------------------------------------------------------------------

#### Add-On Image Management Service

Ensures that when a device returns from being repaired, it has all the proper applications loaded back on the device.

<b>ADD</b> SVCIMAGEMGMT-MOB3	AddOn, Edge Service, Image Service, Mobility, <b>3 Year</b>
------------------------------	-------------------------------------------------------------

#### Add-On Spare Management Service

Manages every aspect of your spare pool.

<b>ADD</b> SVCSPAREMGMT-MOB3	AddOn, Edge Service, Advanced Exchange, Mobility, <b>3 Year</b> . Customer owned spare pool, Minimum Purchase required, contact your local Honeywell Service Representative for more information.
------------------------------	---------------------------------------------------------------------------------------------------------------------------------------------------------------------------------------------------

#### Add-On 2-Day Turnaround Depot Upgrade

Upgrade your Gold Maintenance Contract from 5-Day to 2-Day turnaround at the repair depot.

<b>ADD</b> SVC2DAYDEPOT-MOB3	AddOn, Edge Service, 2-Day Depot Upgrade, 3-Year Agreement, Requires purchase of a <b>3 Year</b> Gold Maintenance Contract.
------------------------------	-----------------------------------------------------------------------------------------------------------------------------

### Platinum Repair Services – 3 Year

The Edge Services Platinum Support contract is the only total support contract in the industry today offering 2-Day Depot Repairs or Spare Pool Management with 3-year contract, that includes:

#### Service Overview

- Repair or replacement of damaged components
- SVCREPLACE-MOB3 - Replacement devices should a device be damaged beyond repair
- SVCACC-MOB3 - Accessory replacement service
- SVCBATTERY-MOB3 - Battery replacement service
- SVCSPAREMGMT-MOB3 - Spare pool management (optional, minimum quantity required)
- Telephone-based technical support
- Android Service - includes Android OS Upgrades, Maintenance Releases and Security Patches

PART NUMBER	DESCRIPTION
SVCCT30XP-SP3N	CT30 XP, Edge Service, PLATINUM, 2 Day Turnaround, <b>3 Year</b> , New Contract



# HONEYWELL EDGE SERVICES

## CT30 XP – Repair Services

Honeywell Edge Services give you the confidence of having leading-class technologies combined with service and support plans that are designed to keep you operational for longer.

### Gold Repair Services – 5 Year

The most flexible contract in the industry. The Edge Services Gold Support contract allows you to select the right coverage for your organization, including 5-Day Depot Repairs and:

#### Service Overview

- Repair or replacement of damaged components, wear and tear, and accidental damage.
- Flexibility to add any Add-On Service
- Android Service - includes Android OS Upgrades, Maintenance Releases and Security Patches

PART NUMBER	DESCRIPTION
SVCCT30XP-SG5N	CT30 XP, Edge Service, GOLD Maintenance Contract, 5 Day Turnaround, <b>5 Year</b> , New Contract

#### Add-On Accessory Replacement Service

Provides replacement chargers, docks, charging cables, or scan handles should they be damaged or stop working.

<b>ADD</b> SVCACC-MOB5	AddOn, Edge Service, Accessory Service , Mobility, <b>5 Year</b> . Service covers docks, charger cradles, scan handles
------------------------	------------------------------------------------------------------------------------------------------------------------

#### Add-On Battery Replacement Service

Provides replacement batteries every 18 months after purchase.

<b>ADD</b> SVCBATTERY-MOB5	AddOn, Edge Service, Battery Service, Mobility, <b>5 Year</b> , 2 Replacement Battery over life of contract
----------------------------	-------------------------------------------------------------------------------------------------------------

#### Add-On Device Replacement Service

Replacement devices should a device be damaged beyond repair.

<b>ADD</b> SVCREPLACE-MOB5	AddOn, Edge Service, Device Replacement, Mobility, <b>5 Year</b>
----------------------------	------------------------------------------------------------------

#### Add-On Image Management Service

Ensures that when a device returns from being repaired, it has all the proper applications loaded back on the device.

<b>ADD</b> SVCIMAGEMGMT-MOB5	AddOn, Edge Service, Image Service, Mobility, <b>5 Year</b>
------------------------------	-------------------------------------------------------------

#### Add-On Spare Management Service

Manages every aspect of your spare pool.

<b>ADD</b> SVCSPAREMGMT-MOB5	AddOn, Edge Service, Advanced Exchange, Mobility, <b>5 Year</b> . Customer owned spare pool, Minimum Purchase required, contact your local Honeywell Service Representative for more information.
------------------------------	---------------------------------------------------------------------------------------------------------------------------------------------------------------------------------------------------

#### Add-On 2-Day Turnaround Depot Upgrade

Upgrade your Gold Maintenance Contract from 5-Day to 2-Day turnaround at the repair depot.

<b>ADD</b> SVC2DAYDEPOT-MOB5	AddOn, Edge Service, 2-Day Depot Upgrade, 5-Year Agreement, Requires purchase of a <b>5 Year</b> Gold Maintenance Contract.
------------------------------	-----------------------------------------------------------------------------------------------------------------------------

### Platinum Repair Services – 5 Year

The Edge Services Platinum Support contract is the only total support contract in the industry today offering 2-Day Depot Repairs or Spare Pool Management with 5-year contract, that includes:

#### Service Overview

- Repair or replacement of damaged components
- SVCREPLACE-MOB5 - Replacement devices should a device be damaged beyond repair
- SVCACC-MOB5 - Accessory replacement service
- SVCBATTERY-MOB5 - Battery replacement service
- SVCSPAREMGMT-MOB5 - Spare pool management (optional, minimum quantity required)
- Telephone-based technical support
- Android Service - includes Android OS Upgrades, Maintenance Releases and Security Patches

PART NUMBER	DESCRIPTION
SVCCT30XP-SP5N	CT30 XP, Edge Service, PLATINUM, 2 Day Turnaround, <b>5 Year</b> , New Contract





# HONEYWELL REPAIR SERVICES

## CT30 XP – Repair Services Coverage

For Best-In-Class Service

CT30 XP



Warranty Cover Against Product Defect

BASIC Service

Gold Coverage:

- Accidental Damage
- Wear & Tear
- Android Service

Includes Replacement of:

- Handstrap
- Screen Protector



Flexible GOLD Add-Ons ordered separately

- SVCACC-MOB3      Accessories
- SVCBATTERY-MOB3      Batteries
- SVCREPLACE-MOB3      Device Replacement
- SVCIMAGEMGMT-MOB3      Image Service
- SVCSPAREMGMT-MOB3      Advanced Exchange

GOLD Service

Platinum Coverage

- Battery Replacement
- Coverage for Docks/ Chargers
- Android Service

- Accidental Damage
- Device Replacement
- Wear & Tear



Pistol Grip



Carry Clip



USB Cables



Battery  
(3 Year – 1 replacement battery per CT30 XP)  
(5 Year – 2 replacement batteries per CT30 XP)



Docks



Dock Power Supplies

PLATINUM Service

COVERAGE	PART NUMBER	DESCRIPTION
<b>BASIC</b>	SVCCT30XP-EXW2	CT30 XP, BASIC, 10-15 Day Turnaround, 2 Years (1 Year Factory Warranty + 1 Year Extended)
<b>GOLD</b>	SVCCT30XP-SG3N	CT30 XP, Edge Service, GOLD Maintenance Contract, 5 Day Turnaround, 3 Year, New Contract
<b>ADD</b>	SVCACC-MOB3	AddOn, Edge Service, Accessory Service, Mobility, 3 Year. Service covers docks, charger cradles, scan handles and car adapter
<b>ADD</b>	SVCBATTERY-MOB3	AddOn, Edge Service, Battery Service, Mobility, 3 Year, 1 Replacement Battery over life of contract
<b>ADD</b>	SVCREPLACE-MOB3	AddOn, Edge Service, Device Replacement, Mobility, 3 Year
<b>ADD</b>	SVCIMAGEMGMT-MOB3	AddOn, Edge Service, Image Service, Mobility, 3 Year
<b>ADD</b>	SVCSPAREMGMT-MOB3	AddOn, Edge Service, Advanced Exchange, Mobility, 3 Year. Customer owned spare pool, Minimum Purchase required.
<b>PLATINUM</b>	SVCCT30XP-SP3N	CT30 XP, Edge Service, PLATINUM, 2 Day Turnaround, 3 Year, New Contract

# CT30 XP SOFTWARE

## Device Client Pack

The Device Client Pack (DCP) includes Launcher, Enterprise Browser, BasicTE, and Mobility Web SDK, these applications are pre-loaded on the device.

All CT30 XP units include a 1 Year DCP Termed Pre-License for initial evaluation of the DCP applications (it does NOT include a Perpetual Pre-License), after the 1 Year Term period expires, a Perpetual or Term license is required to be purchased.

There are two licensing options that can be purchased for DCP:

1. Perpetual License Purchase DCP-001 - Perpetual Licenses operate without expiration for the authorized software version features, and includes 1 year of Maintenance. Add additional Software Maintenance separately.
2. Term + Maintenance License Purchase DCP-SFT1, DCP-SFT2, DCP-SFT3, DCP-SFT4 or DCP-SFT5 - Term + Maintenance Licenses provide software operation, software new version features, and tech support, all for a defined period.

### Device Client Pack

### Order Separately



Launcher



Launcher - gives the customer total control over which apps can be run on the device.



BasicTE

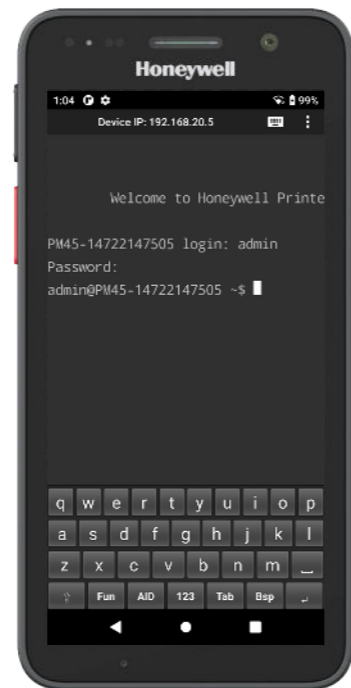

BasicTE Android device Terminal Emulation is a simplified alternative for those not yet ready to upgrade to SmartTE.



Enterprise Browser



Enterprise Browser provides corporations the ability to run standard web applications from a controlled environment.



SmartTE Terminal Emulator



Terminal Emulator – Full featured SmartTE allows legacy green screen apps to be transformed to the look and feel of native apps. These clients are single session Honeywell TE Licensing. They can also utilize traditional single or multi-session StayLinked Licenses.

SmartTE is Pre-Loaded, but requires license SMARTTE-001 to be purchased separately.

PART NUMBER	DESCRIPTION
DCP-001	Device Client Pack Perpetual License (DCP) includes 1 Year Software Maintenance. License covers Launcher, Enterprise Browser, BasicTE, and Mobility Web SDK. Purchase additional years of Software Maintenance DCP-SFT1, DCP-SFT2, DCP-SFT3, DCP-SFT4 or DCP-SFT5 prior to maintenance expiring.
DCP-SFT1	Device Client Pack - 1 Year Term + Maintenance (License covers Launcher, Enterprise Browser, BasicTE, and Mobility Web SDK)
DCP-SFT2	Device Client Pack - 2 Year Term + Maintenance (License covers Launcher, Enterprise Browser, BasicTE, and Mobility Web SDK)
DCP-SFT3	Device Client Pack - 3 Year Term + Maintenance (License covers Launcher, Enterprise Browser, BasicTE, and Mobility Web SDK)
DCP-SFT4	Device Client Pack - 4 Year Term + Maintenance (License covers Launcher, Enterprise Browser, BasicTE, and Mobility Web SDK)
DCP-SFT5	Device Client Pack - 5 Year Term + Maintenance (License covers Launcher, Enterprise Browser, BasicTE, and Mobility Web SDK)

PART NUMBER	DESCRIPTION
SMARTTE-001	SMARTTE - SINGLE PATH W-1 Year Maintenance
SMARTTE-SFT3	SMARTTE - 3 Year Software Maintenance
SMARTTE-SFT5	SMARTTE - 5 Year Software Maintenance

# CT30 XP SCANNING

## Scan Handle Side by Side Comparison

Use for Scan intensive applications.



	PART NUMBER	DESCRIPTION
1	CT30P-SH-00	CT30 XP Scan Handle, compatible with CT30 XP without protective boot.
2	CT30P-SH-UVB	CT30 XP Scan Handle, compatible with CT30 XP with Protective Boot (order CT30-PB-XP separately)
3	CT30P-PB-XP	CT30 XP protective boot. It is compatible with booted universal docks (CT30P-xx-UVB-x). A boot with the ability to expose the CT30 XP's PTT button.

# CT30 XP SCANNING

## Option 1 - Scan Handle

Use for Scan intensive applications, also compatible with using Rear Camera with Scan Handle installed.

This scan handle is ONLY compatible with Non-Booted charging docks.



Side View



Rear View

PART NUMBER	DESCRIPTION	
1	CT30P-SH-00	CT30 XP Scan Handle, compatible with CT30 XP without protective boot. Compatible for use with Home Base and Charge Base without removal.
	CT30P-HB-UVN-0	Non-Booted Home Base
	CT30P-EB-UVN-0	Non-Booted Ethernet Home Base
	CT30P-DB-UVN-0	Non-Booted Display Base
	CT30P-CB-UVN-0	Non-Booted Quad Charge Base
	CT30P-NB-UVN-0	Non-Booted Quad Net Base
	CT30P-HB-UVB-0	Booted Home Base
	CT30P-EB-UVB-0	Booted Ethernet Home Base
	CT30P-DB-UVB-0	Booted Display Base
	CT30P-CB-UVB-0	Booted Quad Charge Base
CT30P-NB-UVB-0	Booted Quad Net Base	
CT30P-5CB-UVN-BAT-0	Non-Booted 5-Bay Charge Base	
CT30P-5CB-UVN-0	Non-Booted 5-Bay Charge Base	
CT30P-5CB-UVB-BAT-0	Booted 5-Bay Charge Base	
CT30P-5CB-UVB-0	Booted 5-Bay Charge Base	

# CT30 XP SCANNING

## Option 2 - Scan Handle with Protective Boot

Use for Scan intensive applications, also compatible with using Rear Camera with Scan Handle installed.  
 This scan handle is ONLY compatible with Booted charging docks.



PART NUMBER	DESCRIPTION	
1	CT30P-SH-UVB	CT30 XP Scan Handle, compatible with CT30 XP with protective boot (order CT30P-PB-XP protective boot separately).. Compatible for use with Protective Boot Home Base and Charge Base without removal.
	CT30P-HB-UVB-0	Booted Home Base
	CT30P-EB-UVB-0	Booted Ethernet Home Base
	CT30P-DB-UVB-0	Booted Display Base
	CT30P-CB-UVB-0	Booted Quad Charge Base
	CT30P-NB-UVB-0	Booted Quad Net Base
	CT30P-HB-UVN-0	Non-Booted Home Base
	CT30P-EB-UVN-0	Non-Booted Ethernet Home Base
	CT30P-DB-UVN-0	Non-Booted Display Base
	CT30P-CB-UVN-0	Non-Booted Quad Charge Base
CT30P-NB-UVN-0	Non-Booted Quad Net Base	
2	CT30P-PB-XP	CT30 XP protective boot. It is compatible with booted universal docks (CT30P-xx-UVB-x). A boot with the ability to expose the CT30 XP's PTT button.

# CT30 XP PROTECTIVE BOOT

## Dockable Protective Boot

Use when protective boot is required with or without scan handle and dockable, compatible with handstrap installed.

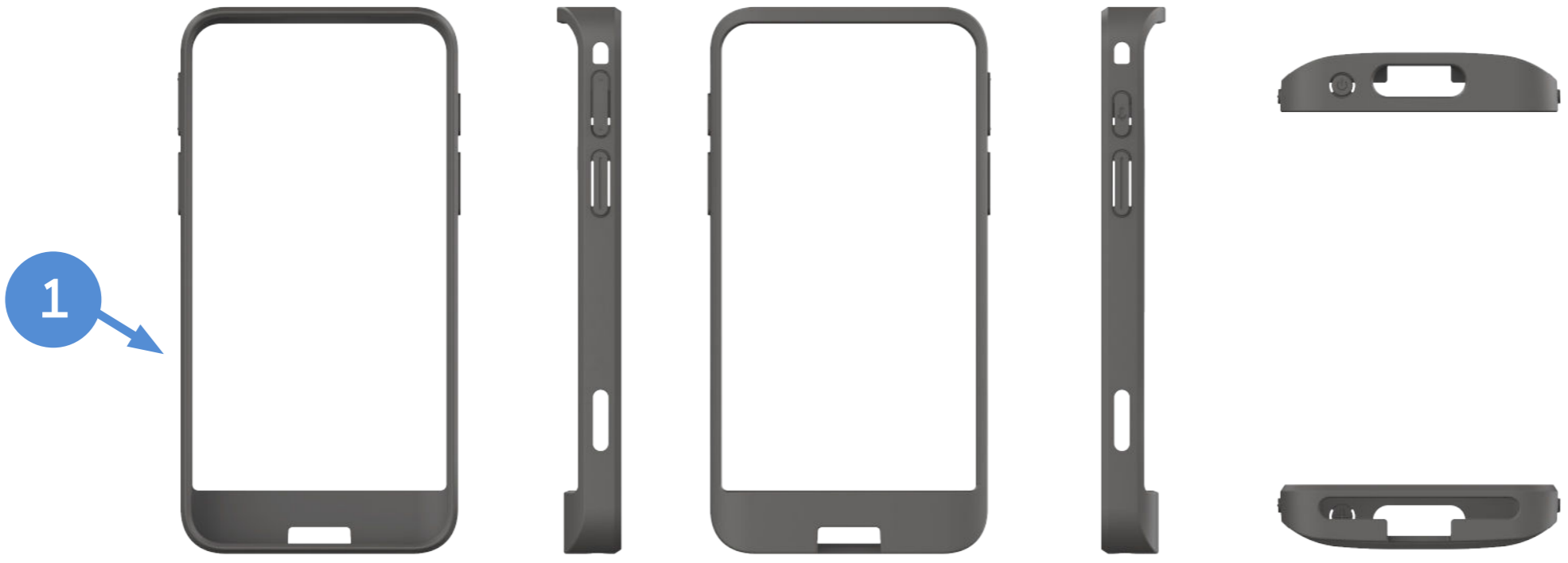

PART NUMBER	DESCRIPTION
1 CT30P-PB-XP	CT30 XP protective boot. It is compatible with booted universal docks (CT30P-xx-UVB-x). A boot with the ability to expose the CT30 XP's PTT button.

# CT30 XP CARRY CLIP

## Option 1 – Standard Carry Clip

The carry clip is for use with WLAN units only, it is not compatible with WWAN units.  
 Not Compatible with CT30P-PB-XP Protective Boot or Handstrap.



## Option 2 – Healthcare Carry Clip

The carry clip is for use with WLAN units only, it is not compatible with WWAN units.  
 Not Compatible with CT30P-PB-XP Protective Boot or Handstrap.



**PART NUMBER**      **DESCRIPTION**

<b>1</b>	CT30P-CLIP-STD	CT30 XP carrying clip. Snaps on top of CT30 XP terminal of WLAN configuration (CT30P-LON-xxxxxxx and (CT30P-XON-xxxxxxx). 1 piece is included in the kit.
----------	----------------	--------------------------------------------------------------------------------------------------------------------------------------------------------------

**PART NUMBER**      **DESCRIPTION**

<b>1</b>	CT30P-CLIP-HC	CT30 XP healthcare carrying clip. Snaps on top of CT30 XP healthcare terminal of WLAN configuration (CT30P-XON-30D10HG). Built with disinfectant-ready, healthcare grade plastic. 1 piece is included in the kit.
----------	---------------	----------------------------------------------------------------------------------------------------------------------------------------------------------------------------------------------------------------------

# CT30 XP DESKTOP COMMUNICATIONS

## Option 1 – USB Type C On-The-Go (OTG) Desktop

USB C Communication to PC/ Mac OR Charging.

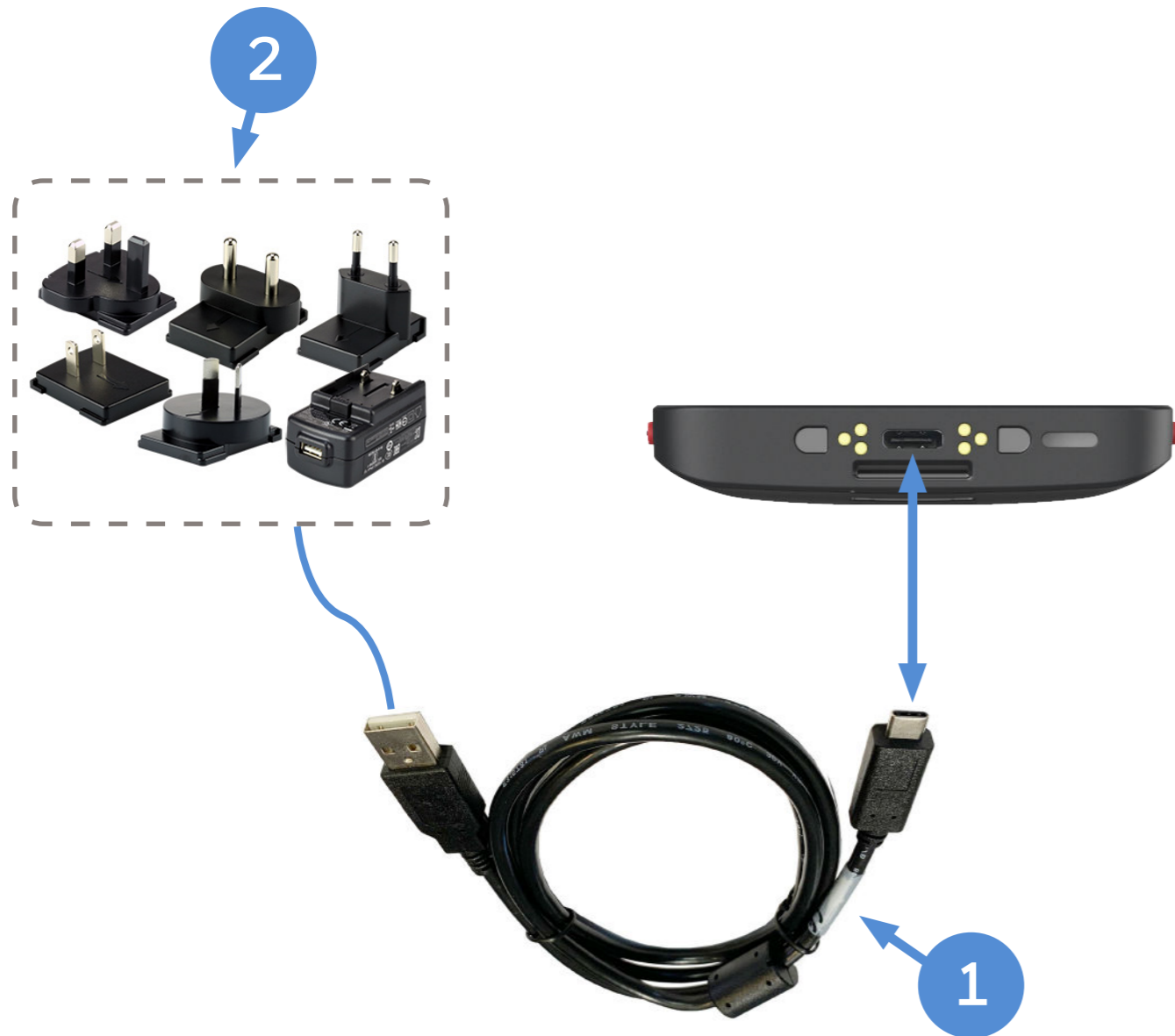

**PART NUMBER**      **DESCRIPTION**

<b>1</b>	CBL-500-120-S00-05	USB type A to type C, 1.2 m (3.9 ft)
<b>2</b>	50136024-001	KIT,5V/2A PS,5 PLUGS PACKED, ROW Includes US,UK,AU,EU,IN adapters

## Option 2 – Fixed with Universal Cup

USB and optional Ethernet Communication & Single Battery Charger.



**PART NUMBER**      **DESCRIPTION**

<b>1A</b>	CT30P-HB-UVN-0	<b>Non-Booted</b> HomeBase - Kit includes (CT30P-UCP-N), Dock & Power Supply, No Power Cord
<b>OR</b>	CT30P-EB-UVN-0	<b>Non-Booted</b> eHomeBase – <b>Ethernet</b> Kit includes (CT30P-UCP-N), Dock & Power Supply, No Power Cord
<b>1B</b>	CT30P-HB-UVB-0	<b>Booted</b> HomeBase - Kit includes (CT30P-UCP-B), Dock & Power Supply, No Power Cord
<b>OR</b>	CT30P-EB-UVB-0	<b>Booted</b> eHomeBase – <b>Ethernet</b> Kit includes (CT30P-UCP-B), Dock & Power Supply, No Power Cord
<b>2</b>	321-576-004	Cable Assembly - USB Type A to Type B
<b>3</b>	**	IEC C13 AC Power Cord – See Page 34 for Country Specific Power Cords



# CT30 XP DESKTOP COMMUNICATIONS

## Option 3 - Display Base with Universal Cup

Connect USB peripherals (keyboard, mouse) and External Monitor via HDMI.



PART NUMBER	DESCRIPTION
1A	CT30P-DB-UVN-0 <b>Non-Booted</b> Display Dock - Kit includes (CT30P-UCP-N), Display Base & Power Supply, No Power Cord
1B	CT30P-DB-UVB-0 <b>Booted</b> Display Dock - Kit includes (CT30P-UCP-B), Display Base & Power Supply, No Power Cord
2	** IEC C13 AC Power Cord – See Page 34 for Country Specific Power Cords

# CT30 XP CHARGING AND COMMUNICATION

## Option 1 - Non-Booted Quad Charger with Universal Cup

Chargebase – Quad Dock Charge Only  
 Netbase – Quad Dock with Ethernet  
 Not Compatible with CT30P-PB-XP Protective Boot

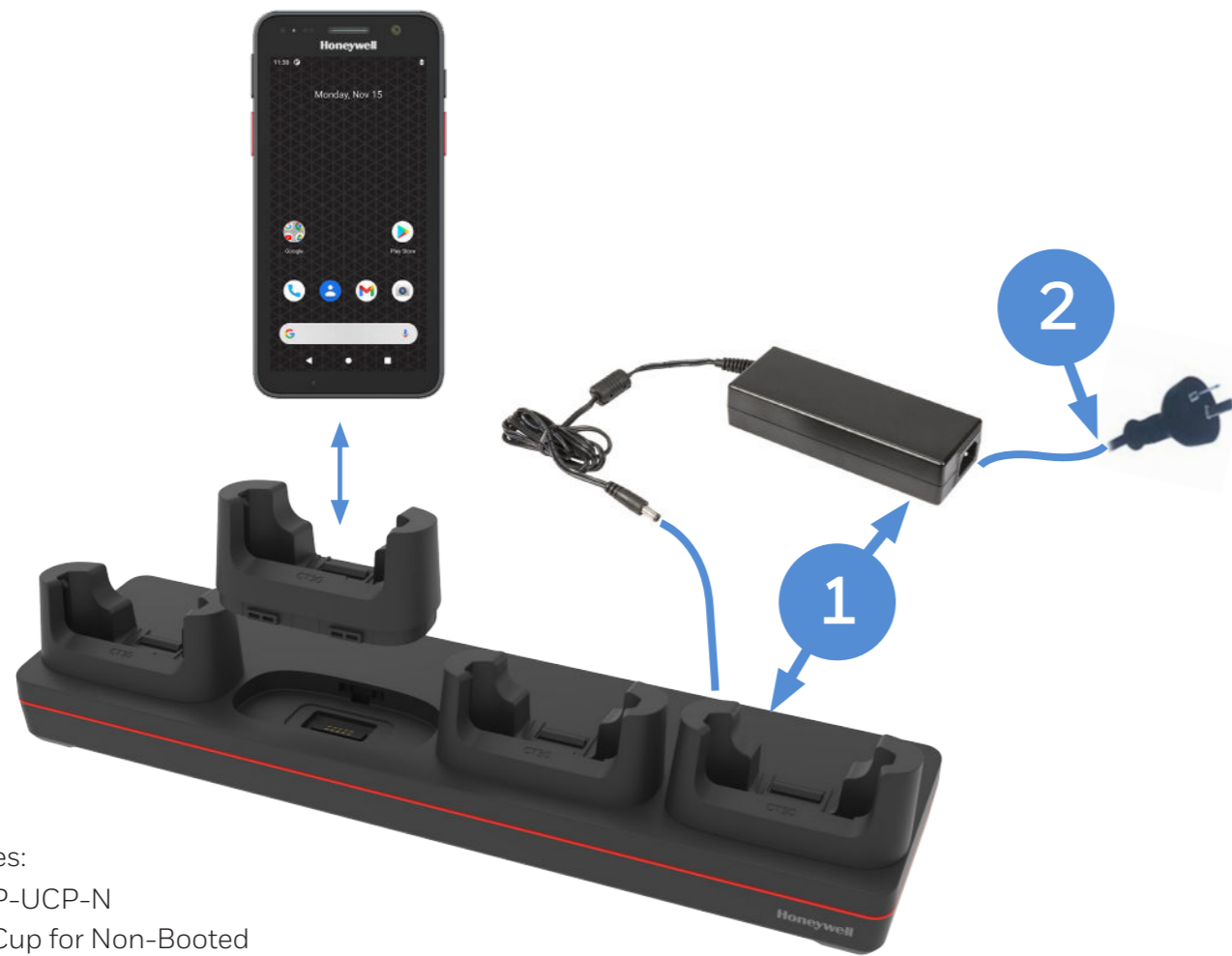

Kit Includes:  
 4 x CT30P-UCP-N  
 CT30 XP Cup for Non-Booted

## Option 2 - Booted Quad Charger with Universal Cup

Chargebase – Quad Dock Charge Only  
 Netbase – Quad Dock with Ethernet  
 Compatible with CT30P-PB-XP Protective Boot



Kit Includes:  
 4 x CT30P-UCP-B  
 CT30 XP Cup for Booted

	PART NUMBER	DESCRIPTION
1	CT30P-CB-UVN-0	<b>Non-Booted</b> Chargebase - Kit includes Dock and Power Supply
OR	CT30P-NB-UVN-0	<b>Non-Booted</b> Netbase - For Ethernet comms, Kit includes Dock and Power Supply
2	**	IEC C13 AC Power Cord – See Page 34 for Country Specific Power Cords

	PART NUMBER	DESCRIPTION
1	CT30P-CB-UVB-0	<b>Booted</b> Chargebase - Kit includes Dock and Power Supply
OR	CT30P-NB-UVB-0	<b>Booted</b> Netbase - For Ethernet comms, Kit includes Dock and Power Supply
2	**	IEC C13 AC Power Cord – See Page 34 for Country Specific Power Cords

# CT30 XP CHARGING AND COMMUNICATION

## Option 3 - Non-Booted 5-Bay Charge

Chargebase – 5-Bay Charge Only (5 terminals)  
 Not Compatible with CT30P-PB-XP Protective Boot  
 Compatible with CT30P-SH-00 Non-Booted Scan Handle



Kit Includes:  
 5 x CT30P-UCP-N  
 CT30 XP Cup for Non-Booted

## Option 4 - Booted 5-Bay Charger

Chargebase – 5-Bay Charge Only (5 terminals)  
 Compatible with CT30P-PB-XP Protective Boot  
 Compatible with CT30P-SH-UVB Booted Scan Handle



Kit Includes:  
 5 x CT30P-UCP-B  
 CT30 XP Cup for Booted

**PART NUMBER      DESCRIPTION**

<b>1</b>	CT30P-5CB-UVN-0	CT30 XP <b>Non-Booted</b> 5 bay Universal Dock, charge up to 5 pieces of CT30 XP . Kit includes 5 bay Universal Dock and Power Adaptor. IEC C5 Power cord must be ordered separately.
<b>2</b>	**	IEC C5 AC Power Cord – See Page 34 for Country Specific Power Cords

**PART NUMBER      DESCRIPTION**

<b>1</b>	CT30P-5CB-UVB-0	CT30 XP <b>Booted</b> 5 bay Universal Dock, charge up to 5 pieces of CT30 XP. Kit includes 5 bay Universal Dock and Power Adaptor. IEC C5 Power cord must be ordered separately.
<b>2</b>	**	IEC C5 AC Power Cord – See Page 34 for Country Specific Power Cords

# CT30 XP CHARGING AND COMMUNICATION

## Option 5 - Non-Booted 5-Bay Charger with Battery Cup

Chargebase – Quad Dock Charge Only (4 terminals) and Quad Battery Charger (4 batteries)

Not Compatible with CT30P-PB-XP Protective Boot

Compatible with CT30P-SH-00 Non-Booted Scan Handle



Top View with Scan Handle installed



Kit Includes:  
 4 x CT30P-UCP-N  
 CT30 XP Cup for Non-Booted  
 1 x CT30P-QBC-UCP  
 Batteries not included.

## Option 6 - Booted 5-Bay Charger with Battery Cup

Chargebase – Quad Dock Charge Only (4 terminals) and Quad Battery Charger (4 batteries)

Compatible with CT30P-PB-XP Protective Boot

Compatible with CT30P-SH-UVB Booted Scan Handle



Top View with Protective Boot installed



Kit Includes:  
 4 x CT30P-UCP-B  
 CT30 XP Cup for Booted  
 1 x CT30P-QBC-UCP  
 Batteries not included.

**PART NUMBER DESCRIPTION**

<b>1</b>	CT30-5CB-UVN-BAT-0	CT30 XP <b>Non-Booted</b> 5 bay Universal Dock, charge up to 4 pieces of CT30 XP and 4 pieces of CT30 XP batteries. Kit includes 5 bay Universal Dock and Power Adaptor. IEC C5 Power cord must be ordered separately.
<b>2</b>	**	IEC C5 AC Power Cord – See Page 34 for Country Specific Power Cords

**PART NUMBER DESCRIPTION**

<b>1</b>	CT30-5CB-UVB-BAT-0	CT30 XP <b>Booted</b> 5 bay Universal Dock, charge up to 4 pieces of CT30 XP and 4 pieces of CT30 XP batteries. Kit includes 5 bay Universal Dock and Power Adaptor. IEC C5 Power cord must be ordered separately.
<b>2</b>	**	IEC C5 AC Power Cord – See Page 34 for Country Specific Power Cords

# CT30 XP CHARGING AND COMMUNICATION

## Option 7 - Quad Battery Charger

Charge up to 4 batteries simultaneously

Supports Batteries: CT30P-BTSC-001 - Battery, Standard, CT30 XP DRH (3400mAh)

CT30P-BTSC-002 - Battery, Standard, CT30 XP Healthcare (3400mAh)

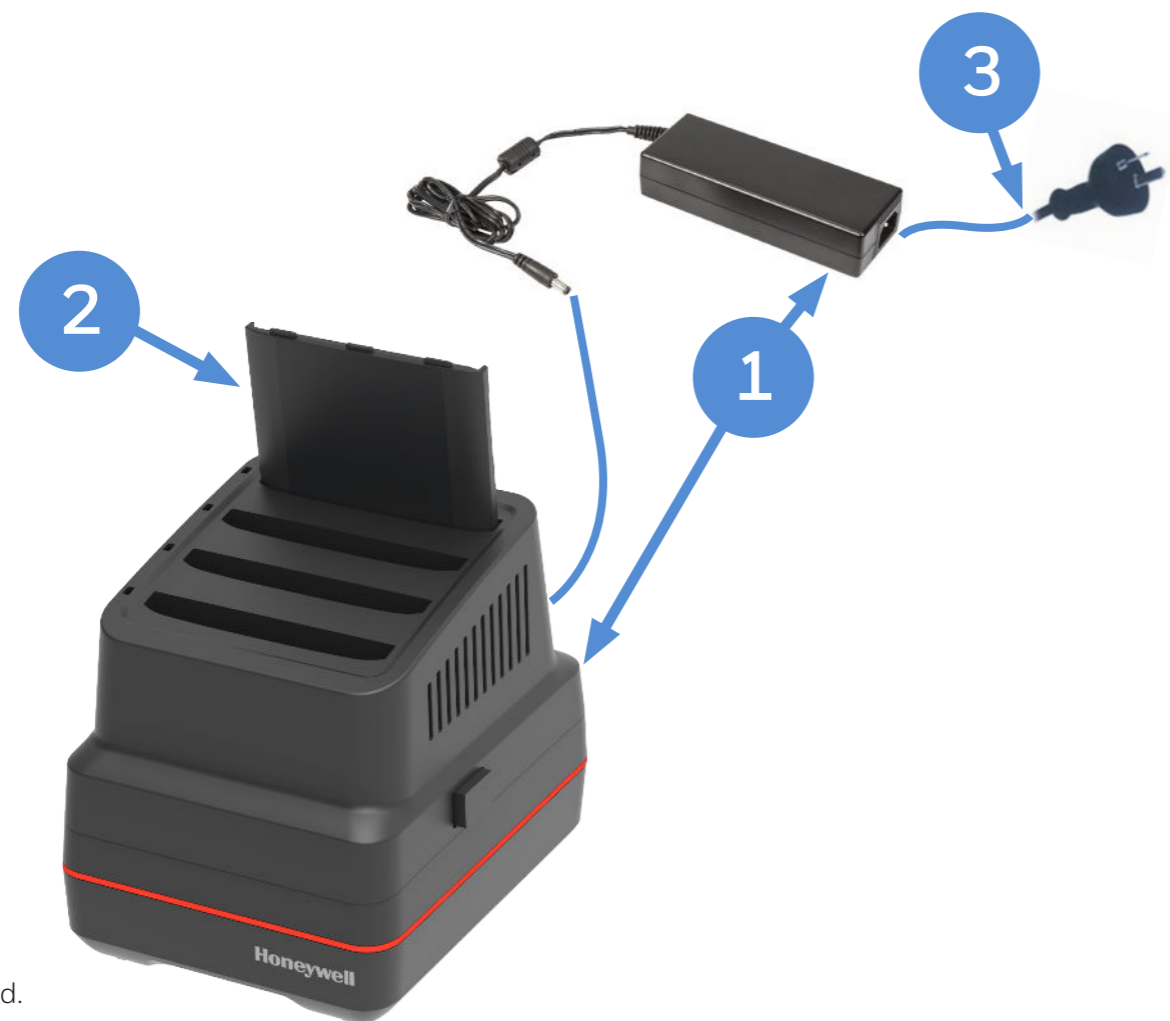

Batteries not included.

PART NUMBER	DESCRIPTION
1	CT30P-QBC-0 Quad Battery Charger - Kit includes Dock and Power Supply
2	CT30P-BTSC-001 Battery, Standard, CT30 XP DRH (3400mAh)
3	** IEC C13 AC Power Cord - See Page 34 for Country Specific Power Cords

## Universal Battery Cup

Compatible with 5-Bay bases CT30-5CB-UVN-BAT-0, CT30-5CB-UVB-BAT-0 and Quad Battery Charger CT30P-QBC-0.

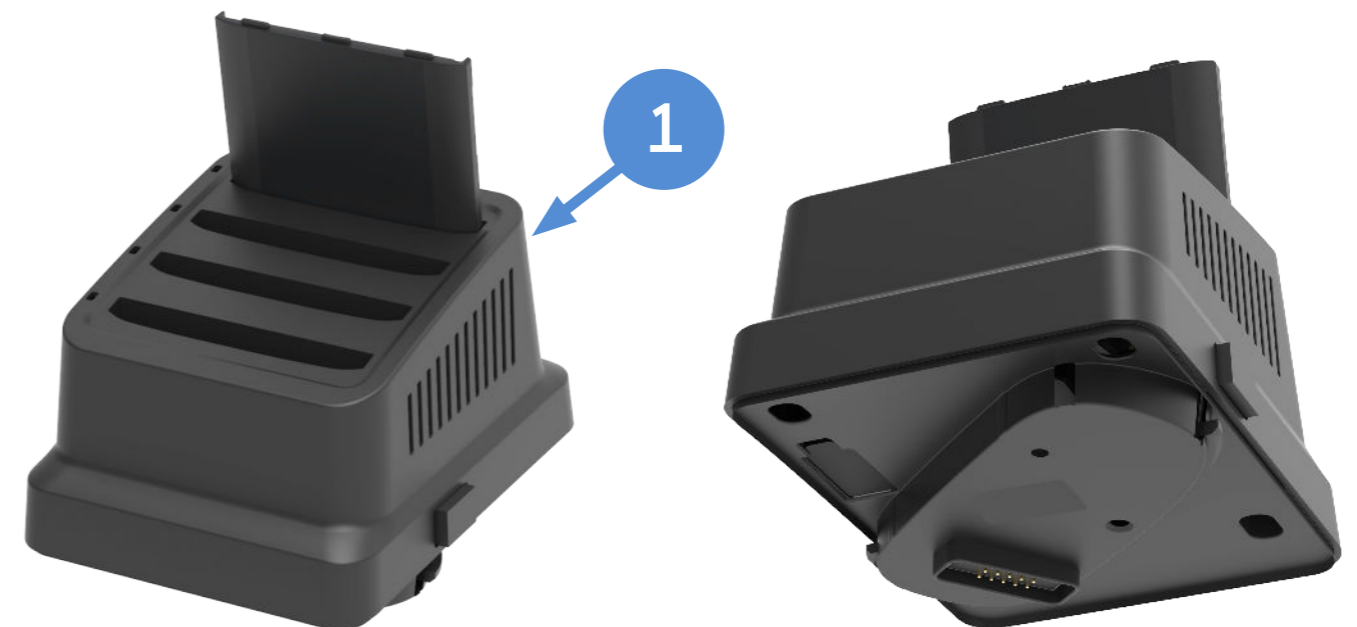

Batteries not included.

PART NUMBER	DESCRIPTION
1	CT30P-QBC-UCP CT30 XP battery universal cup. Kit includes a cup to be used for up to 4 pcs CT30 XP batteries

# CT30 XP HEALTHCARE CHARGING AND COMMUNICATION

## Option 1 - Non-Booted 5-Bay Charger with Battery Cup

Chargebase – Quad Dock Charge Only (4 terminals) and Quad Battery Charger (4 batteries)  
 Not Compatible with CT30P-PB-XP Protective Boot



Top View

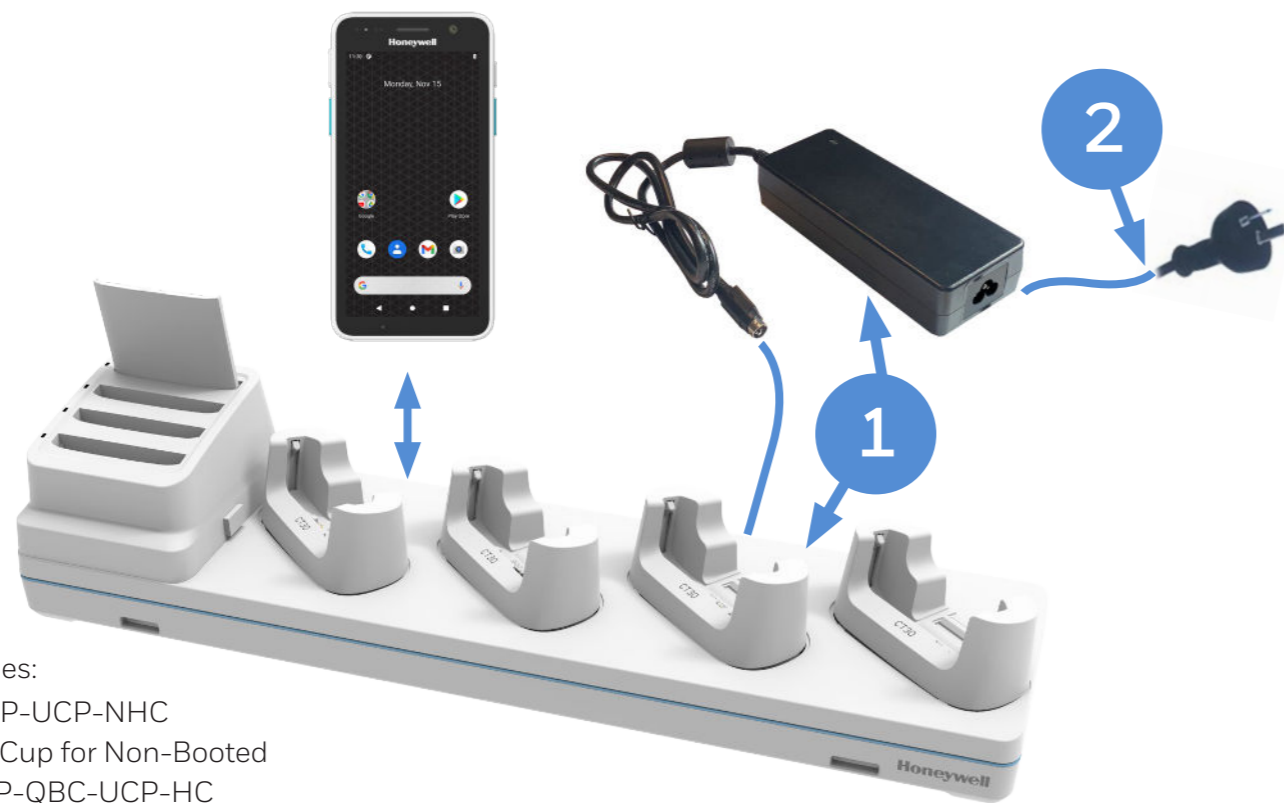

Kit Includes:  
 4 x CT30P-UCP-NHC  
 CT30 XP Cup for Non-Booted  
 1 x CT30P-QBC-UCP-HC  
 Batteries not included.

## Option 2 - Booted 5-Bay Charger with Battery Cup

Chargebase – Quad Dock Charge Only (4 terminals) and Quad Battery Charger (4 batteries)  
 Compatible with CT30P-PB-XP Protective Boot



Top View with Protective Boot installed



Kit Includes:  
 4 x CT30P-UCP-BHC  
 CT30 XP Cup for Booted  
 1 x CT30P-QBC-UCP-HC  
 Batteries not included.

**PART NUMBER DESCRIPTION**

<b>1</b>	CT30-5CB-UVN-HCO	CT30 XP <b>Non-Booted</b> 5 bay Universal Dock, charge up to 4 pieces of CT30 XP Healthcare and 4 pieces of CT30 XP batteries. Kit includes 5 bay Universal Dock and Power Adaptor. IEC C5 Power cord must be ordered separately.
<b>2</b>	**	IEC C5 AC Power Cord – See Page 34 for Country Specific Power Cords

**PART NUMBER DESCRIPTION**

<b>1</b>	CT30-5CB-UVB-HCO	CT30 XP <b>Booted</b> 5 bay Universal Dock, charge up to 4 pieces of CT30 XP Healthcare and 4 pieces of CT30 XP batteries. Kit includes 5 bay Universal Dock and Power Adaptor. IEC C5 Power cord must be ordered separately.
<b>2</b>	**	IEC C5 AC Power Cord – See Page 34 for Country Specific Power Cords

# CT30 XP HEALTHCARE CHARGING AND COMMUNICATION

## Option 3 - Display Base with Universal Cup

Connect USB peripherals (keyboard, mouse) and External Monitor via HDMI.

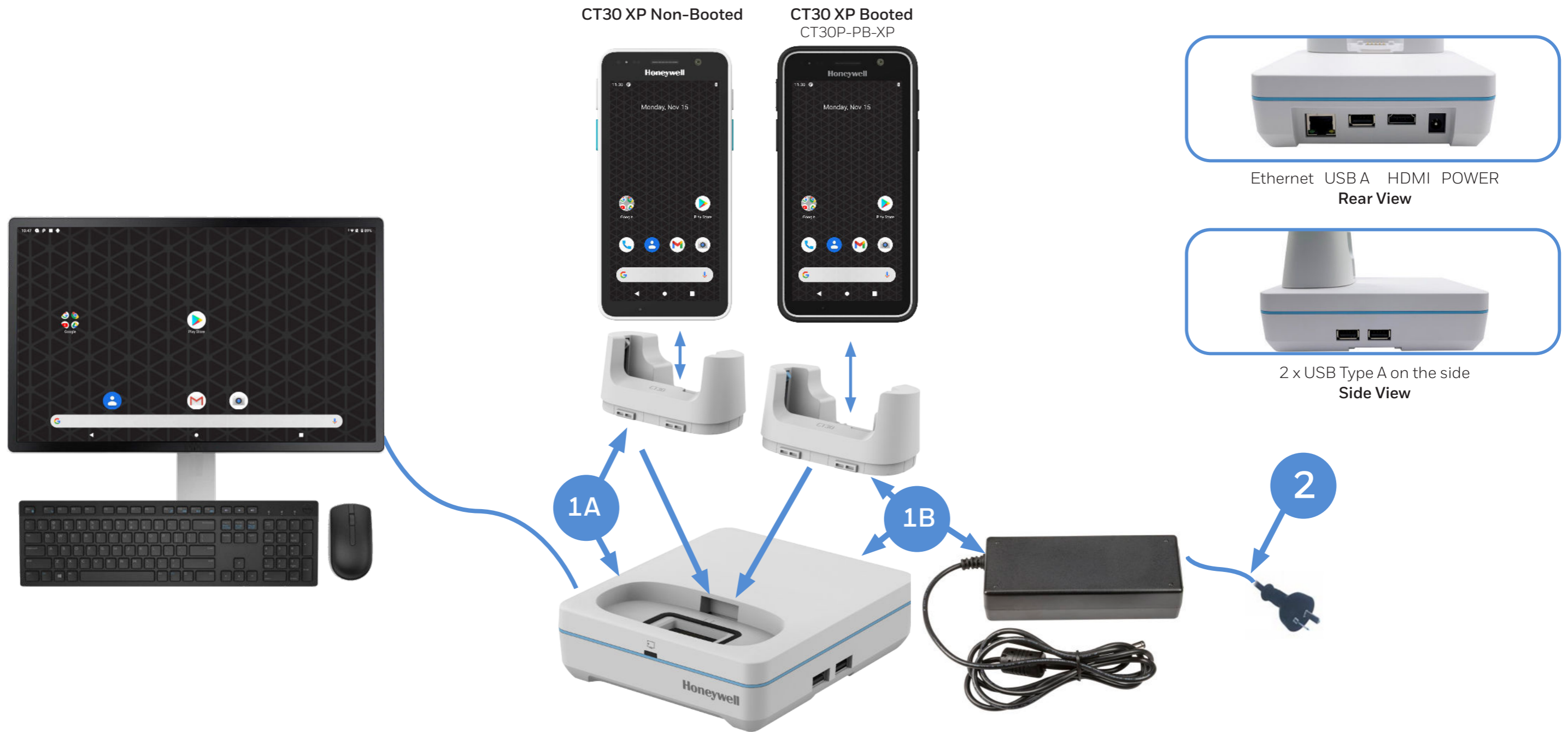

PART NUMBER	DESCRIPTION
1A	CT30P-DB-UVN-HCO <b>Non-Booted</b> Healthcare Display Dock - Kit includes (CT30P-UCP-NHC), Display Base & Power Supply, No Power Cord
1B	CT30P-DB-UVB-HCO <b>Booted</b> Healthcare Display Dock - Kit includes (CT30P-UCP-BHC), Display Base & Power Supply, No Power Cord
2	** IEC C13 AC Power Cord - See Page 34 for Country Specific Power Cords

# CT30 XP HEALTHCARE CHARGING AND COMMUNICATION

## Option 4 - Quad Battery Charger

Charge up to 4 batteries simultaneously

Supports Batteries: CT30P-BTSC-001 - Battery, Standard, CT30 XP DRH (3400mAh)

CT30P-BTSC-002 - Battery, Standard, CT30 XP Healthcare (3400mAh)

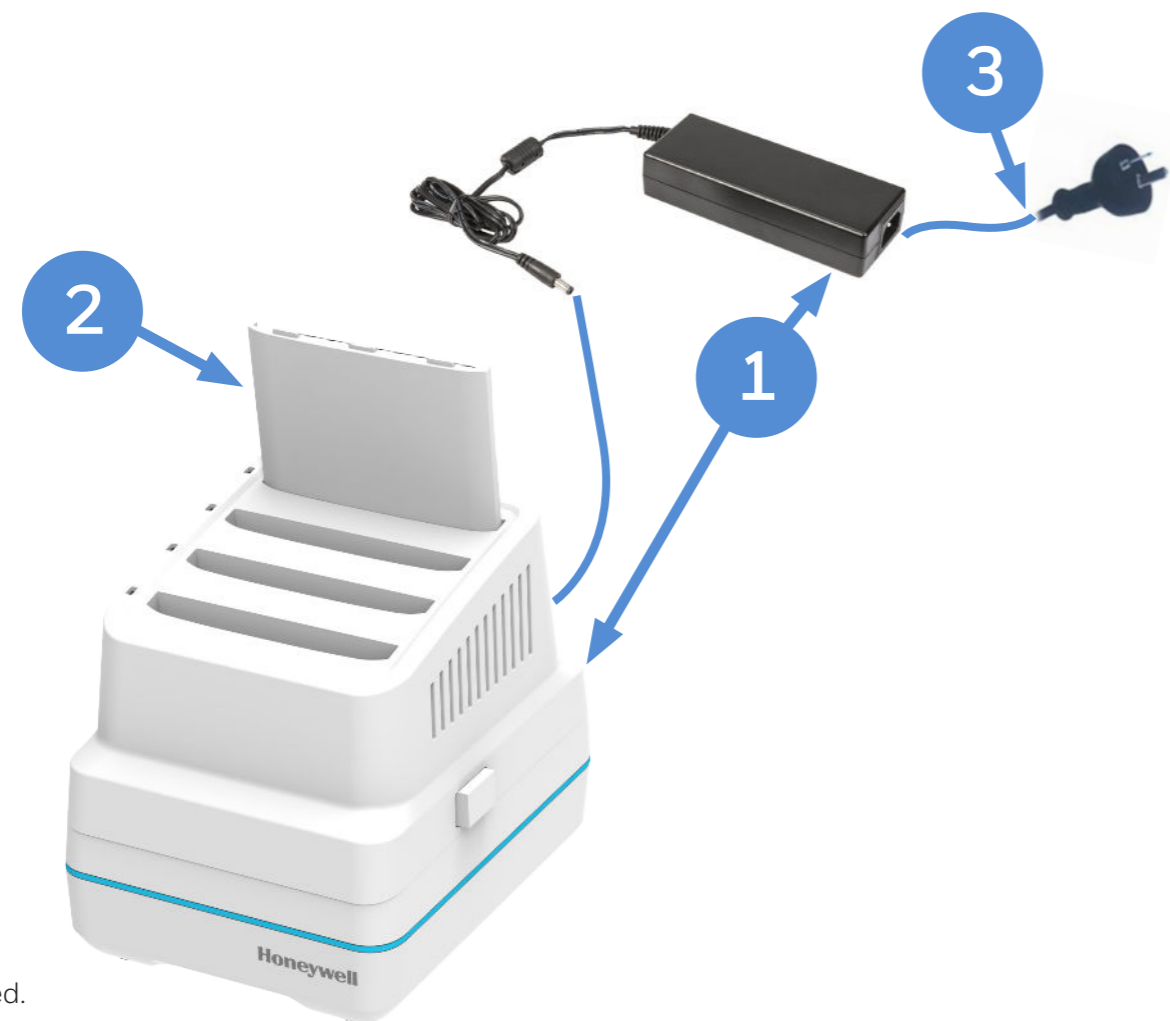

Batteries not included.

PART NUMBER	DESCRIPTION
1	CT30P-QBC-HC0 Healthcare Quad Battery Charger - Kit includes Dock and Power Supply
2	CT30P-BTSC-002 Battery, Standard, CT30 XP Healthcare (3400mAh)
3	** IEC C13 AC Power Cord - See Page 34 for Country Specific Power Cords



# CT30 XP CHARGING AND COMMUNICATION

## Rack / Wall Mount Bracket

The Rack/Wall Mount Bracket has been optimized to work on a standard 19-inch (48cm) rack, as well as mounting directly onto a wall. Compatible with all 4-bay chargers.

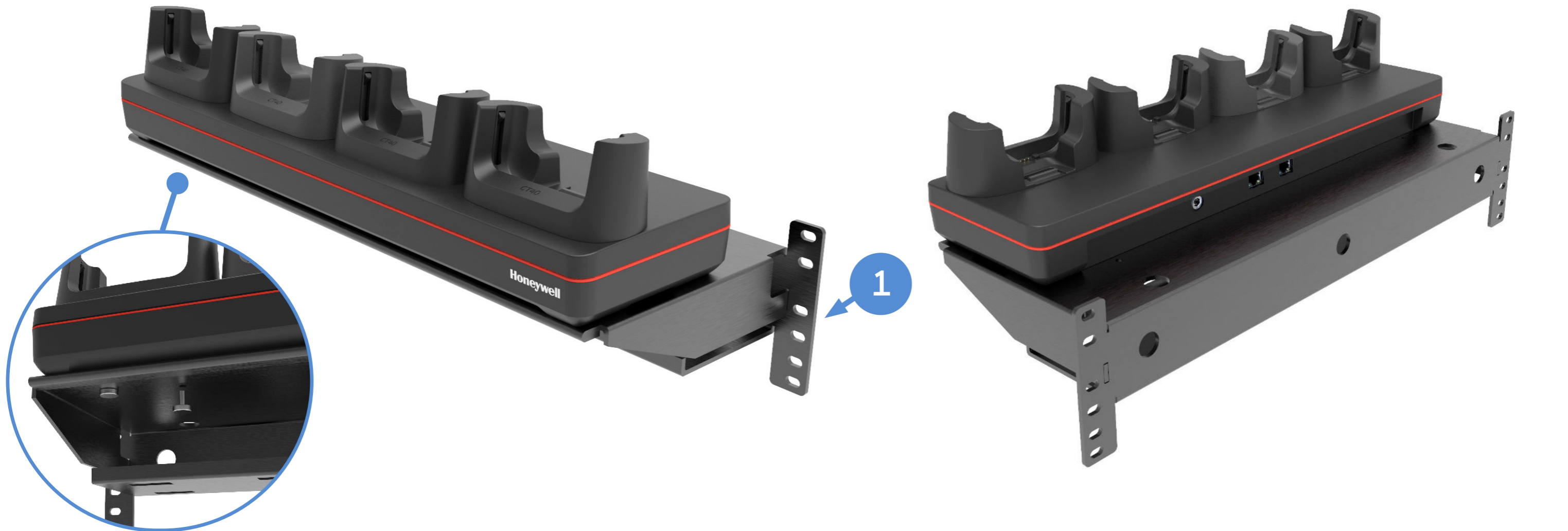

Thumb Screws View



Front View



Rear View



Power Supply Shelf View



Bottom View

	PART NUMBER	DESCRIPTION
1	CB-BK-01	4 Bay Charger Bracket, Rack / Wall Mount (includes 4 x 50180100-001 Thumb Screws M3.5x10 to securely attach the 4-bay dock to the bracket)

# CT30 XP BATTERY

## Spare Battery Options



**CT30 XP Disinfectant Ready**  
 CT30P-xxx-xxxxxDx  
 CT30P-xxx-xxxxNx

**CT30 XP Healthcare**  
 CT30P-xxx-xxxxHx

PART NUMBER	DESCRIPTION
1 CT30P-BTSC-001	CT30 XP disinfectant ready battery pack, 3400mAh, for use with CT30 XP disinfectant-ready configurations (last two digits in part number begin with D or N: CT30P-xxx-xxxxxDx or CT30P-xxx-xxxxNx)
2 CT30P-BTSC-002	CT30 XP healthcare battery pack, 3400mAh, for use with CT30 XP healthcare configurations (last two digits in part number begin with H: CT30P-xxx-xxxxHx)

# CT30 XP RFID

## IH40 RFID Reader with CT30 XP Non-Booted

Connect the IH40 to the CT30 XP via Bluetooth or USB.

IH40 has a user accessible replaceable battery.

Not compatible with CT30P-PB-XP Protective Boot



IH40 Front View



IH40 Rear View



IH40 Top View

	PART NUMBER	REGION	DESCRIPTION
<b>1</b>	IH40-1-N003S02UK	FCC / ANZ	IH40 High-Performance UHF RFID tag reader, US Frequency Range of RFID output (902-928MHz), Includes Battery
<b>OR</b>	IH40-1-N003S02OK	ETSI	IH40 High-Performance UHF RFID tag reader, EU Frequency Range of RFID output (865-868 MHz), Includes Battery
<b>2</b>	CT30P-IH40-BR		IH40 bracket for <b>Non-Booted</b> CT30 XP
<b>3</b>	50155100-001		IH25 Wrist Strap

### Honeywell Repair Services

SVCIH40-SG3N

IH40, Edge Service, Gold Maintenance Contract, 3 Year, New Contract

# CT30 XP RFID CHARGING

## Option 1 - IH40 Non-Booted Quad Charger

IH40 shares the same chargers as CT40/ CT45.

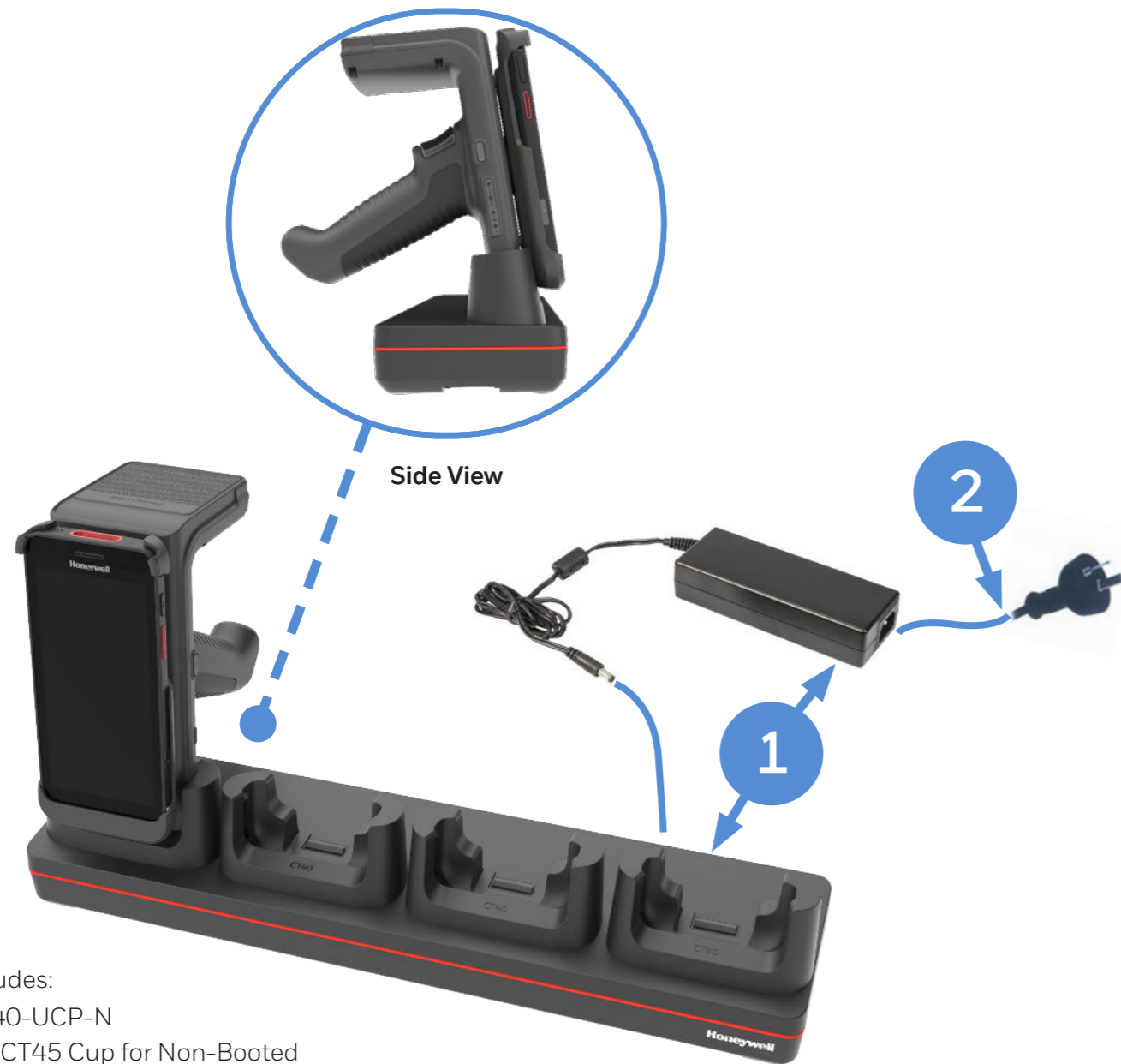

Kit Includes:  
4 x CT40-UCP-N  
CT40 / CT45 Cup for Non-Booted

## Option 2 - IH40 Booted Quad Charger

IH40 shares the same chargers as CT40/ CT45.

When using CT40 Booted chargers, the adapter sleeve is required to fit the IH40.

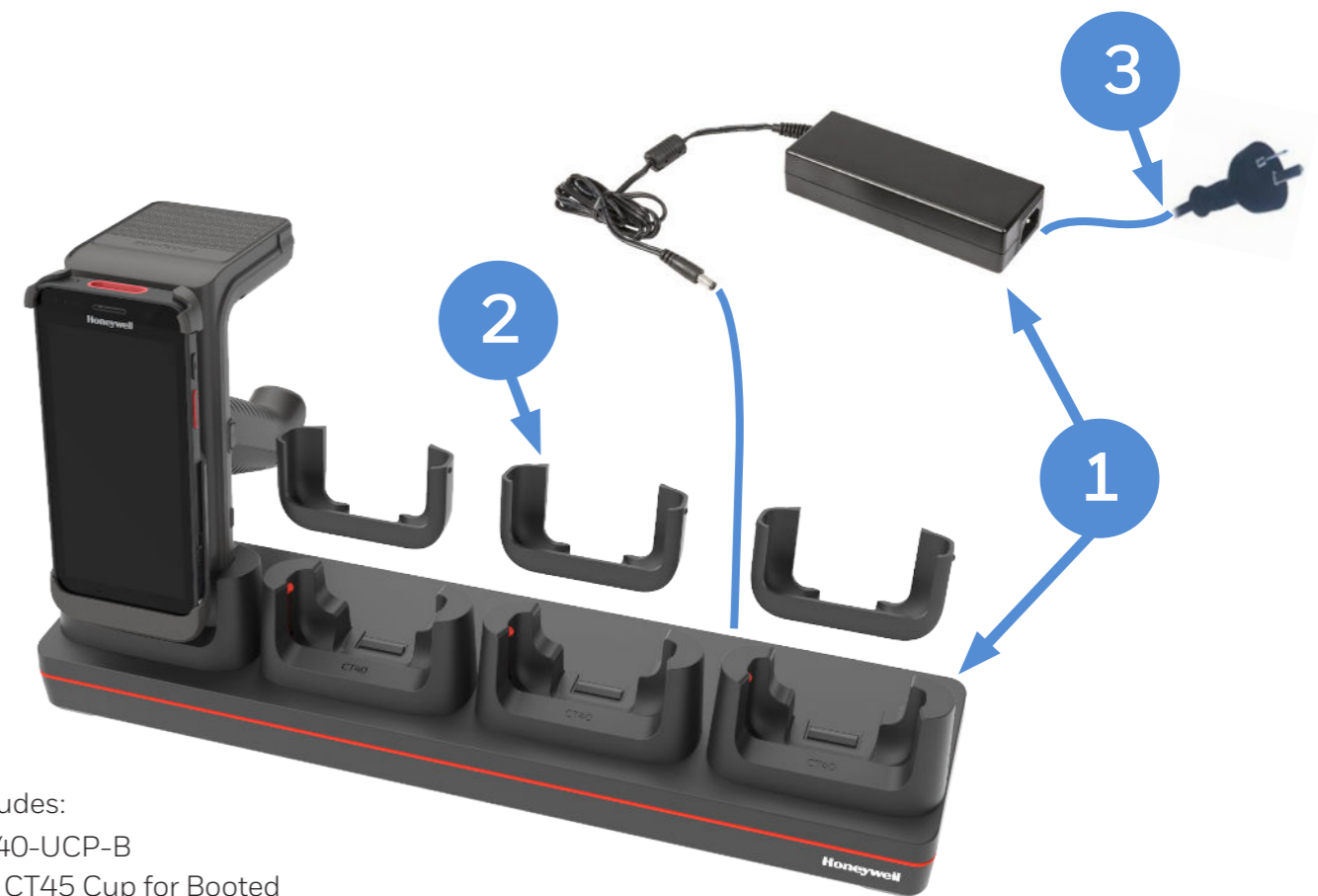

Kit Includes:  
4 x CT40-UCP-B  
CT40 / CT45 Cup for Booted

**PART NUMBER      DESCRIPTION**

<b>1</b>	CT40-CB-UVN-0	<b>Non-Booted</b> Chargebase - Kit includes Dock and Power Supply
<b>OR</b>	CT40-NB-UVN-0	<b>Non-Booted</b> Netbase - For Ethernet comms, Kit includes Dock and Power Supply
<b>2</b>	**	IEC C13 AC Power Cord – See Page 34 for Country Specific Power Cords

**PART NUMBER      DESCRIPTION**

<b>1</b>	CT40-CB-UVB-0	<b>Booted</b> Chargebase - Kit includes Dock and Power Supply
<b>OR</b>	CT40-NB-UVB-0	<b>Booted</b> Netbase - For Ethernet comms, Kit includes Dock and Power Supply
<b>2</b>	IH40-ADP-SLV	IH40 Adapter Sleeve for <b>Booted</b> CT40 cup (CT40-UCP-B) - Order 4 adapters per Charge Base
<b>3</b>	**	IEC C13 AC Power Cord – See Page 34 for Country Specific Power Cords

# CT30 XP RFID CHARGING

## Option 3 - IH40 Quad Battery Charger

IH40 shares the same chargers as EDA50/ EDA51 battery charger.

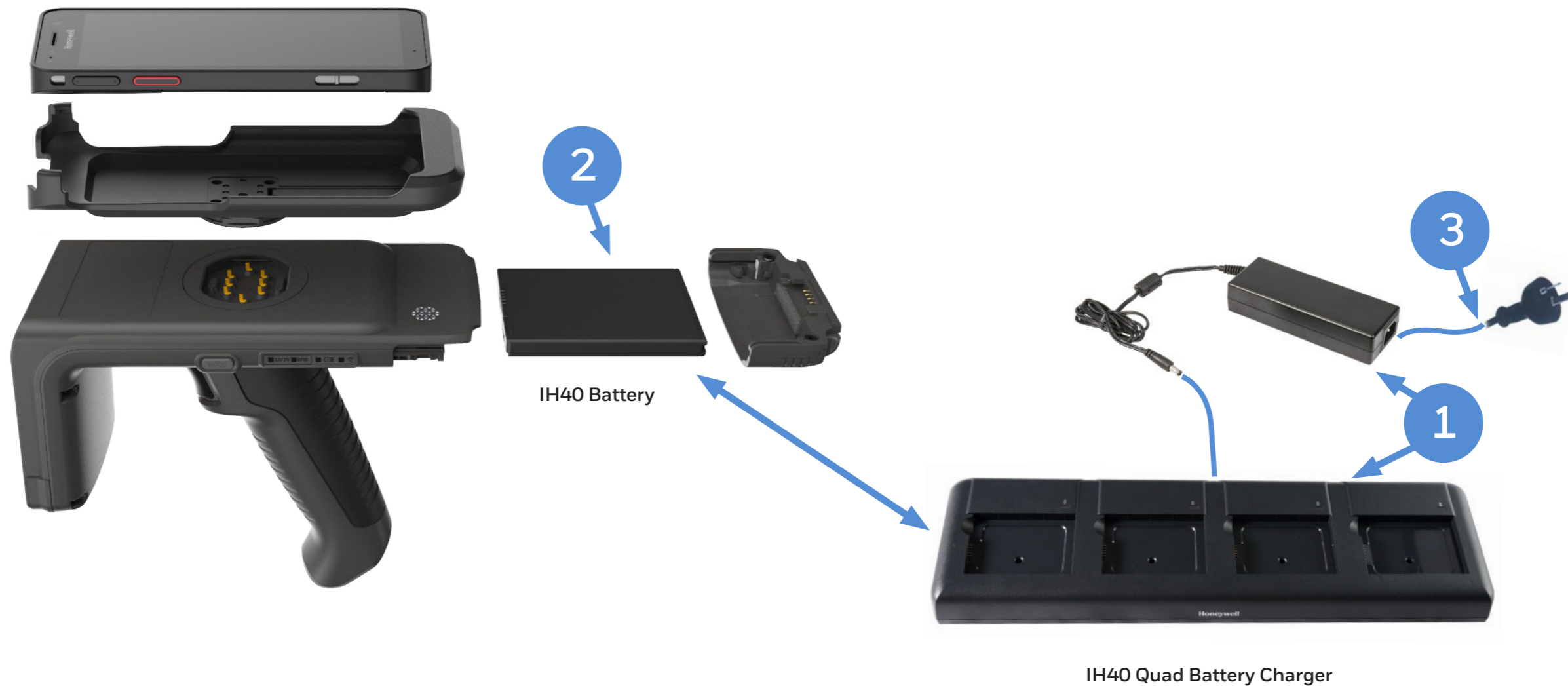

PART NUMBER	DESCRIPTION
1	EDA50-QBC-0 Kit IH25/IH40/EDA50/EDA70/EDA71 Quad Battery Charger. Kit includes Dock, Power Supply, No Power Cord.
2	50129589-001 Accessory, Battery (3.8V, 4,000mAh), EDA50/51/70/71
3	** IEC C13 AC Power Cord – See Page 34 for Country Specific Power Cords

# CT30 XP HEADSET

## USB-C CT30 XP Push To Talk (PTT) Headset

USB-C audio PTT and VoIP ready to support In-Store Communication with leading 3rd party applications.  
Compatible with CT30P-PB-XP Protective Boot



PART NUMBER	DESCRIPTION
1 MBL-HDST-USBC	Headset with PTT, USB C

# CT30 XP WEARABLE

## Wearable Kit

A lightweight forearm mount for handsfree operation.



## Wearable Kit - Replacement Parts

Purchase replacement armbands, rubber pads and sleds for your wearable kits.



PART NUMBER	DESCRIPTION
1 CT30P-WS-KIT	CT30 XP wearable kit, includes the Armband, Sled and Rubber pad. It is NOT compatible with CT30 XP with protective boot.

PART NUMBER	DESCRIPTION
1 CT30P-WS-KIT-01	CT30XP Wearable Kit, Spare Armband, 3 pieces per pack
2 CT30P-WS-KIT-02	CT30XP Wearable Kit, Spare Rubber Pad, 2 pieces per pack
3 CT30P-WS-KIT-03	CT30XP Wearable kit, Spare Sled, 2 pieces per pack

# MISCELLANEOUS

## Optional Parts



PART NUMBER	DESCRIPTION
CT30P-HS-3PK	CT30 XP hand strap, 3 pieces Not Compatible with Healthcare CT30 XP units.



PART NUMBER	DESCRIPTION
213-048-001	Pack of 5 CT40 / CT50 / CT60 replacement styluses.
8754-871600-20	Pack of 10 CT40 / CT50 / CT60 replacement styluses.



PART NUMBER	DESCRIPTION
CT30P-SP-1PK	CT30 screen protector, 1 piece per pack. Can be used with stylus.



PART NUMBER	DESCRIPTION
825-237-001	POUCH, CT40/CT50/CT60/CT60 XP



PART NUMBER	DESCRIPTION
825-238-001	CT40/CT50/CT60/CT60 XP Holster



# MISCELLANEOUS

## Optional Parts

Replacement Power Supplies.



PART NUMBER	DESCRIPTION
50121666-001	Power Adapter,12V 3A, No Power Cord, Compatible with CT40 Homebase / eHomebase / Quad Battery Charger (Requires IEC C13 AC Power Cord)

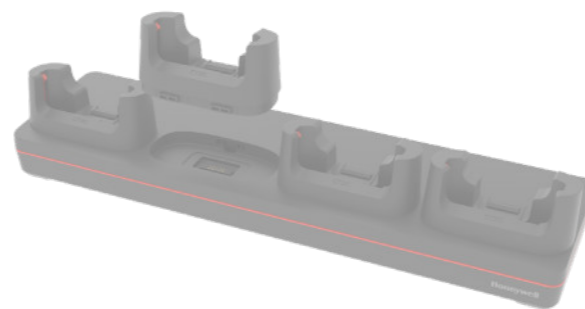

PART NUMBER	DESCRIPTION
50121667-001	Power Adapter,12V 7A, No Power Cord, CT40 Quad Chargebase/Quad Netbase (Requires IEC C13 AC Power Cord)

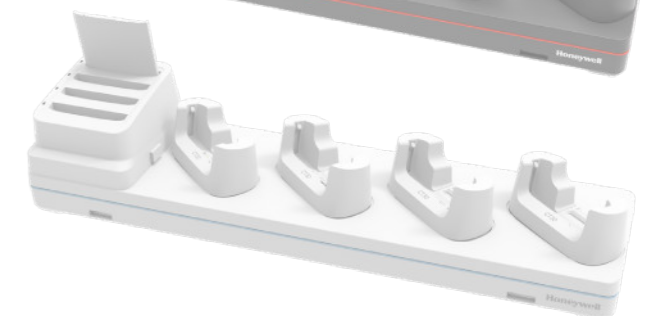
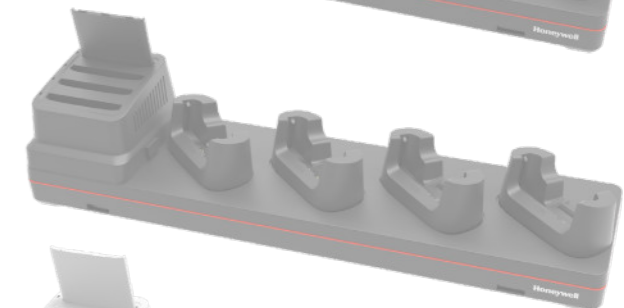
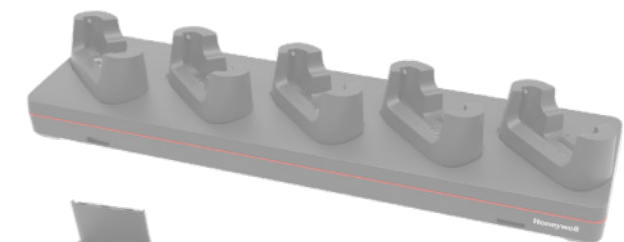

PART NUMBER	DESCRIPTION
3007-3408-001	Power Supply 12V 8.3A R7B ADS-120QL-12-3 120100E 5-Bay Charge Base (Requires IEC C5 AC Power Cord)

# MISCELLANEOUS

## Optional Parts

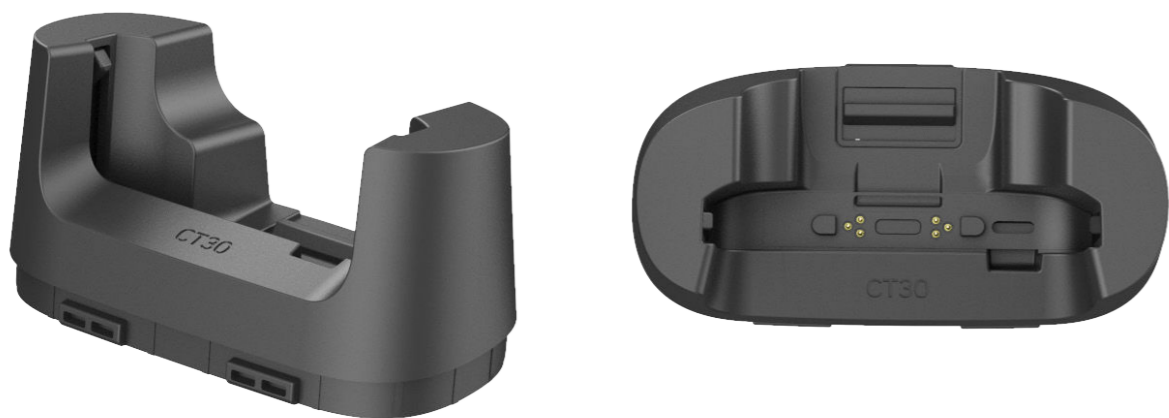

PART NUMBER	DESCRIPTION
CT30P-UCP-N	CT30 XP <b>Non-Booted</b> universal cup, to be used for CT30 XP without protective boot



PART NUMBER	DESCRIPTION
CT30P-UCP-B	CT30 XP <b>Booted</b> universal cup, to be used for CT30 XP with protective boot (CT30P-PB-XP)

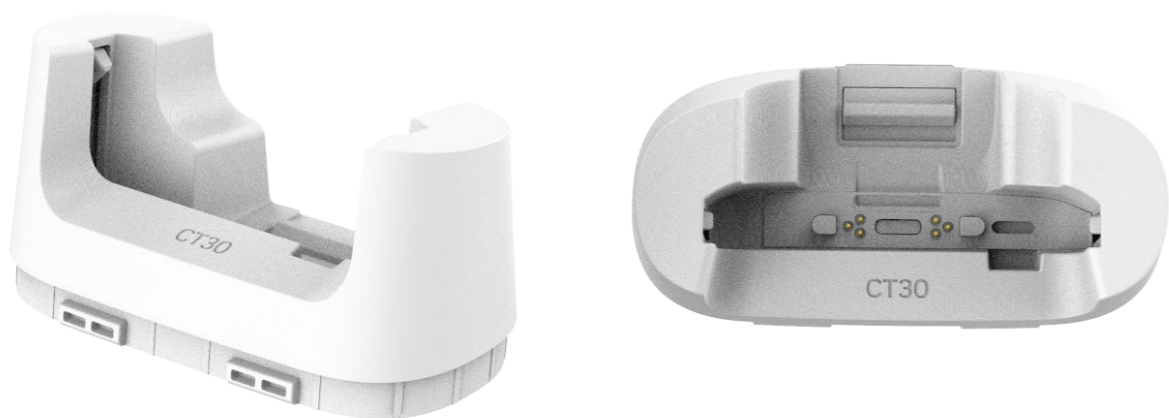

PART NUMBER	DESCRIPTION
CT30P-UCP-NHC	CT30 XP <b>Non-Booted</b> Healthcare universal cup, to be used for CT30 XP without protective boot



PART NUMBER	DESCRIPTION
CT30P-UCP-BHC	CT30 XP <b>Booted</b> Healthcare universal cup, to be used for CT30 XP with protective boot (CT30P-PB-XP)

# MISCELLANEOUS

## Micro-SD Cards

Honeywell Recommended – ATP Industrial Grade Micro SD Cards

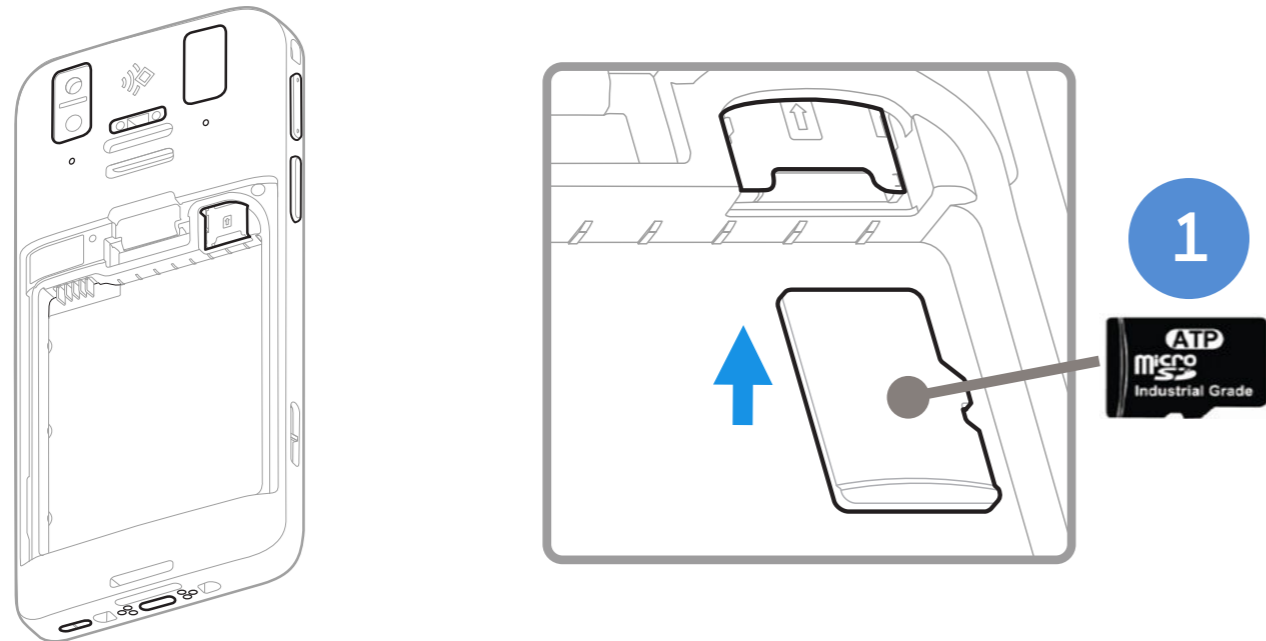

Why ATP Industrial Grade SD?

ATP's SIP (System-In-Packaging) manufacturing process encapsulates all exposed components and points of failure to ensure the products are fully waterproof, shockproof, and ESD (Electro-Static Discharge) proof. ATP Industrial Grade SD/SDHC Cards can withstand at least an operating/storage temperature range of at least -40 to 85 degrees Celsius. In addition to this temperature range, the cards are completely waterproof, dustproof, and ESD (Electro-Static Discharge) proof. All ATP Industrial Grade SD/SDHC cards are produced under a stringent RoHS and Green Package compliant manufacturing process to guarantee a consistent high level of build quality and performance. ATP Industrial SD cards deliver outstanding performance with read speed (seq) up to 18MB/sec and write speed (seq) up to 16MB/sec. All ATP Industrial Grade CF, SD, USB drives, and SSDs are constructed using best-in-class SLC(Single-Level Cell) components with enhanced Error Correction Code(ECC) functions and wear levelling algorithms. This results in MTBF ratings over 2 million hours and the highest write cycle lifetimes in the industry.

	PART NUMBER	DESCRIPTION
<b>1</b>	856-065-004	MICRO-SD CARD, <b>1GB</b> , AFIGUDI, ROHS
<b>OR</b>	856-065-005	MICRO-SD CARD, <b>2GB</b> , AFIGUDI, ROHS
<b>OR</b>	856-065-006	MICRO-SD CARD, <b>4GB</b> , AFIGUDI, ROHS
<b>OR</b>	856-065-007	MICRO-SD CARD, <b>8GB</b> , AFIGUDI, ROHS

## AC Cords

Regional Power Cords



AC Power - C13 Type Connector

PART NUMBER	TYPE	DESCRIPTION
50117501-001	C13	POWER CORD AUSTRALIA 2500MM,SLED CB
321-501-002	C13	AC Power Cord, Denmark RoHS
77900508E	C13	Cable: power cord, straight, Power cord, Europe EU, IEC320-C13, 2.5 m (8.2 ft)
321-502-002	C13	AC Power Cord, India/South Africa RoHS
321-500-002	C13	AC Power Cord, Japan RoHS
9000093CABLE	C13	AC POWER CABLE, C14 TYPE, SWITZERLAND 3-PIN
77900507E	C13	Cable: power cord, straight - Power cord, UK, IEC320-C13, 2.5 m (8.2 ft)
130063	C13	AC Power Cord, US RoHS



AC Power - C5 Type Connector

PART NUMBER	TYPE	DESCRIPTION
3007-4681-001	C5	C5 type power cable, USA
3007-4683-001	C5	C5 type power cable, Europe
3007-4682-001	C5	C5 type power cable, UK
3007-4684-001	C5	C5 type power cable, Australia

# MISCELLANEOUS

## Disclaimer

---

Honeywell International Inc. (“HII”) reserves the right to make changes in specification and other information contained in this document without prior notice, and the reader should in all cases consult HII to determine whether any such changes have been made. The information in this publication does not represent a commitment on the part of HII.

HII shall not be liable for technical or editorial errors or omissions contained herein; nor for incidental or consequential damages resulting the furnishing, performance, or use of this material.

This document contains proprietary information that is protected by copyright. All rights are reserved. No part of this document may be photocopied, reproduced, or translated into another language with-out prior written consent of HII.

Web Address: [www.honeywellaidc.com](http://www.honeywellaidc.com)

The Bluetooth trademarks are owned by Bluetooth SIG, Inc., U.S.A and licensed to Honeywell.

Thor and Mobility Edge are trademarks or registered trademarks of Honeywell International Inc. in the United States and/or other countries.

Android is a trademark or registered trademark of Google Inc. in the United States and/or other countries. Windows is a trademark or registered trademark of Microsoft Corporation.

Qualcomm and Snapdragon are trademarks or registered trademarks of Qualcomm Incorporated in the United States and/or other countries.

Other product names mentioned in the manual may be trademarks of registered trademarks of their respective companies and are the property of their respective owners.

All rights reserved.

### For more information

[sps.honeywell.com](http://sps.honeywell.com)

### Honeywell Safety and Productivity Solutions

300 S Tryon St Suite 500

Charlotte, NC 28202

800-582-4263

[www.honeywell.com](http://www.honeywell.com)